

Ferrite Toroids & Balun Cores

Steward



www.steward.com

ISO 9001:2000 and QS 9000 Certified

CATTFC 11th Edition REV D 02/2006



STEWARD TOROIDS

Table Of Contents

Steward & Quality Assurance	3
Quality Philosophy.....	3
Quality Testing.....	3
Quality Measurement System	3
Part Identification	4
Part Numbers	4
Standard Components	5
Toroidal Core Coatings.....	5
Steward Ferrite Core Materials.....	6
Common Mode Materials	6
Comparing Common Mode Materials	6
Low Frequency Material 35.....	8
Mid Frequency Material 28	9
High Frequency Material 25.....	10
Broad Frequency Material 38.....	11
DC Bias Materials Materials	12
Comparing DC Mode Materials.....	12
DC Bias Standard Temperature (0 to 70 C) Material 36	14
DC Bias Extended Temperature (-40 to 85 C) Material 46	15
Low DC Bias - High Permeability Material 56.....	16
Material 36/46 Minimum Inductance with Various Turns (8 mA DC Bias)	17
High Permeability Materials for Telecom	18
Comparing Telecom Materials	18
Telecom Broad Temperature Material 42	20
Telecom High Permeability Material 40	21
Other Materials	22
Comparing Other Materials.....	22
Material 35	23
Material 39	24
Material Comparison Chart	25
Steward Catalog Toroid Parts	26
Steward Medium & Large Catalog Toroid Parts	30
Balun Core Catalog Parts	31
Ferrite Property Measurement	32
Initial Permeability, Losses & Inductance Factor	32
Changes in Inductance versus Temperature & Curie Temperature.....	32
Flux Density, Residual Flux Density, Coercive Force & Amplitude Permeability	33
Pulse Characteristics.....	34
Power Loss.....	34
Measurement of Impedance Of Ferrite Components	35
Terminology	36

Steward & Quality Assurance

Quality Philosophy

At Steward, customer focus is paramount in our quality program. Our quality philosophy is outlined as follows:

- Steward is a company committed to continuous improvement. We fulfill this commitment by continually improving the quality of the products and services we provide our customers, both external and internal.
- We recognize that our customers define quality. We further recognize that continuous improvement can only result from the fullest development of our people and technologies.
- We believe that to pursue this course, we must set unselfish service as our standard for conduct. Building on the values of our history, we will raise our standards of performance through continuous improvement and imagination. In addition, our actions must demonstrate integrity, honesty, excellence and self-discipline.
- We believe in teamwork. Our commitment to continuous improvement is fulfilled and maintained by the combined, cohesive efforts of people with a common goal.

Quality Measurement System

Steward's Quality Management Systems have been certified to the ISO 9001:2000 requirements by Ceramic Industry Certification Scheme Ltd.



Quality Testing

We test on the following equipment:

Inductance, Loss Factor:	Hewlett-Packard 4274A Multi-Frequency LCR Meter Hewlett-Packard 4275A Multi-Frequency LCR Meter Hewlett-Packard 4284A Multi-Frequency LCR Meter
Impedance:	Hewlett-Packard 4396B Network/Spectrum Analyzer Hewlett-Packard 4991A Network/Spectrum Analyzer

Catalog is provided for informational purposes only. No guarantee is stated or implied. Part specifications are located on the part prints. Steward is not responsible for printing or typographical errors.

Please visit www.Steward.com for the most up-to-date information.

Part Identification

Part Numbers

Steward's part numbers use a ten character alphanumeric nomenclature providing:

- The material designation
- The product type (shape)
- A basic size description
- A parts modifier series

Product Types 35 T _____ - _____

Steward's Transformer and Filter Core Division uses two basic shape designators:

T for toroidal cores

Example: 35T0100-00P

N for balun cores

Example: 35N0136-00P

Basic Size Description 35 T0100 - _____

The four digits following the product description provide the largest dimension of the part in thousandths of an inch. For toroids and similar shapes, it usually describes the outside or major diameter of the core. For other types of parts, it is the largest dimension specified in the part's description.

Steward PART NUMBERING SYSTEM					
<u>35</u>	<u>T</u>	<u>0100</u>	-	<u>0</u>	<u>P</u>
MATERIAL TYPE	PRODUCT CODE	PART SIZE CODE	PART THICKNESS	CATALOG SPECIFICATION	PARYLENE COATING

Material Designator 35 _____ - _____

A two digit material designator is assigned to materials on the basis of initial permeability.

Typical Application	Material	Initial Permeability
Common Mode Filtering	35	5000
	28	850
	25	125
	38	1700
DC Bias Ethernet Transformers	46	4000
	36	4500
	56	5500
High Perm for Telecom	42	7500
	40*	10000
Other Applications	35	5000
	39	7000

* 40 material large toroids are mostly used for very low frequency power supply filtering

Parts Modifier Series 35 T 0100 - 00P

The first of the three digits following the dash refers to the part thickness. A zero through nine digit refers variations in thickness from the same tool. The second modifying digit relates to a custom requirement (electrical testing or physical specification). The third digit or letter describes a coating or finish.

Coating Designations

P — Parylene

Hi-Pot Rating 1000 VAC minimum

Nominal Thickness: 0.0005" / 0.0127 mm

H — Epoxy

Please consult Steward's Website for other products.

Standard Components

Soft Ferrite Typical Physical Constants	
Specific Heat	0.25 cal/g/°C
Thermal Conductivity	10 ⁻² cal/sec/cm/°C
Coefficient of Linear Expansion	8-10 x 10 ⁻⁶ /°C
Tensile Strength	500 kg/cm ²
Compressive Strength	4200 kg/cm ²
Youngs Modulus	1260 kg/cm ²
Hardness (Knoop)	650
Density	4.6 to 4.9 g/cm ³

Mechanical Tolerances	
OD — ID Tolerances	
mm (inches)	
OD — ID	Uncoated Tol.
≤ 5.05 (.199)	.127 (.005)
5.08 (.200) - 9.50 (.374)	.152 (.006)
9.53 (.375) - 15.85 (.624)	.254 (.010)
15.88 (.625) - 25.37 (.999)	.381 (.015)
> 25.40 (1.000)	.508 (.020)
HT Tolerances	
HT	Uncoated Tol.
< 6.32 (.249)	.127 (.005)
6.35 (.250) - 7.34 (.289)	.178 (.007)
> 7.37 (.290)	.254 (.010)

Toroidal Core Coatings

If required by customer applications, smooth, resistive coatings may be provided. Standard dimensions for each toroid are listed in the parts chart, and coating will alter these. Inductance values are as shown for standard sizes and cores are checked after coating to ensure compliance.

Parylene

Parylene is ideally suited for core sizes with outside diameters less than 9.5 mm (0.375"). Parylene is a highly conformal coating with uniform thickness even around corners and edges. It is applied by vapor deposition, which prevents clogging of small openings. The addition of Parylene results in very little increase in core size. It has a high resistivity and a low coefficient of friction (close to that of Teflon), which results in low wire insulation abrasion during winding. Parylene's relatively low dielectric constant is 2.95, resulting in only a small increase of winding-to-core capacitance. After coating, cores are Hi-Pot tested to 1000 VAC volts for single thickness. Higher voltages available upon request via additional coating thicknesses.

Epoxy

Epoxy coating is the choice for cores about 9.5mm (0.375") diameter or larger. It is applied by spraying. Because of its thickness, epoxy coating provides some cushioning during winding. Epoxy coating provides inherent toughness, corrosion resistance, and very good adhesion. These properties are retained even after long term heat aging. After coating, cores are Hi-Pot tested to 1000 VAC.

Please visit www.Steward.com for the most up-to-date information.

Common Mode Materials

35 / 28 / 25 / 38

TYPICAL VALUES			35	28	25	38
PARAMETER	SYMBOL	UNIT	Low Frequency	Mid Frequency	High Frequency	Broad Frequency
Relative Initial Permeability	μ_i		5000	850	125	1700
A_L Tolerance		%	± 20	± 20	± 30	± 30
Saturation Flux Density	B_s	Gauss	4500	3250	3600	3000
		mT	450	325	360	300
at Field Intensity	H	Oersteds	10	10	10	10
		A/m	800	800	800	800
Residual Flux Density	B_r	Gauss	1000	2000	2600	1500
		mT	100	200	260	150
Coercive Force	H_c	Oersteds	0.10	0.40	1.60	0.20
		A/m	8	3	127	16
Relative Loss Factor at Frequency	$\tan \delta \mu_i$ f	10^{-6}	20	91	740	53
		MHz	0.10	0.10	0.10	0.10
Curie Temperature	T_c	$^{\circ}\text{C}$	> 150	> 175	> 225	> 120
Resistivity	ρ	$\Omega\text{-cm}$	100	10^5	10^6	10^5
Density		g/cm^3	4.8	4.9	4.9	4.8

Impedance with 10 Turns Nominal Values				
Part Number	Low Frequency 35 Material @ 10 MHz	Mid Frequency 28 Material @ 150 MHz	High Frequency 25 Material @ 300 MHz	Broad Frequency 38 Material @ 100 MHz
T0100-00	1001	1567	714	966
T0100-20	601	939	434	656
T0119-00	1189	1606	892	1689
T0120-00	878	1268	663	1248
T0135-00	1021	1288	748	1058
T0135-60	1214	1541	895	1269
T0155-10	839	1053	644	911
T0231-00	1109	1409	874	1257

Effect Of Turns On Impedance

Ideally, impedance would be proportional to frequency and the square of the number of turns regardless of the magnitude of either. This is generally the case at very low frequencies, but becomes less valid as frequency increases. The predominant cause of such behavior is interwinding capacitance. Capacitance is directly proportional to the area of the conductor and inversely proportional to the distance between the conductors. As the number of turns increases, the area of the conductor (the length of the wire) increases and the distance between the conductors (the spacing between turns) decreases. The end result is an LC resonance above which capacitive reactance decreases impedance. The number of turns, their spacing, and the uniformity of their spacing are major factors in the frequency response of wound toroidal filters and must therefore be carefully considered in their assembly.

Comparing Materials

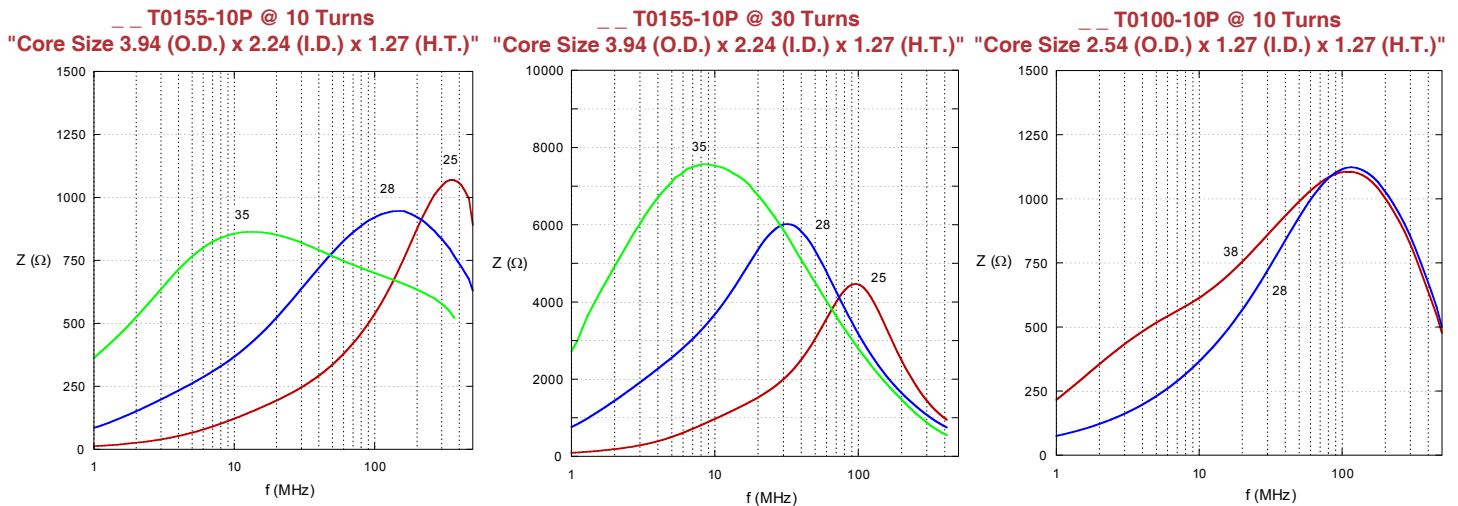

Performance of Differing Permeability Common Mode Materials

Impedance cores are used to suppress unintended signals on or being emitted from cables or wires. If these signals are not accounted for, they can interfere with electronics and/or cause a failure to meet government emissions standards or susceptibility regulations. The cores suppress unintended signals by acting on the magnetic fields that surround the cable or wire.

When a signal travels through a conductor, a magnetic field is generated around that conductor. A ferrite core, if placed around the conductor, can interact with this magnetic field. The magnetic field activates the ferrite, which, in response to the magnetic field, imposes impedance that reduces the magnitude of the unintended signal.

The impedance (Z) that weakens the unintended signal, consists of two components. The first is a reactive component (X). It represents the amount of inductance that exists in the core as a function of frequency. In other words, $X = 2 * \pi * \text{frequency} * \text{inductance} (L)$. The second is a resistive component (R). It results from the core's natural tendency to resist an electrical signal, in this case a magnetic field. The resulting impedance is the square root of the sum of the squares of the resistance and reactance, or $Z = \sqrt{(R^2 + X^2)}$, which is measured in ohms.

Steward low frequency cores have high permeability, resulting in suppression of low frequency signals. As demonstrated in the following chart, the impedance at very low frequencies is principally contributed by the X. At higher frequencies the R predominates.

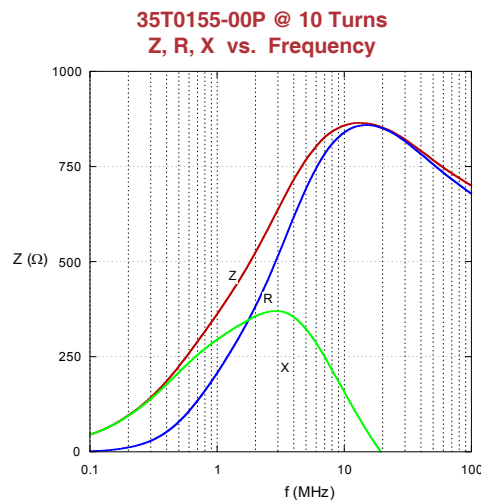

Please visit www.Steward.com for the most up-to-date information.

Material 35

Common Mode Low Frequency

5000 Permeability

Initial Permeability vs. Temperature

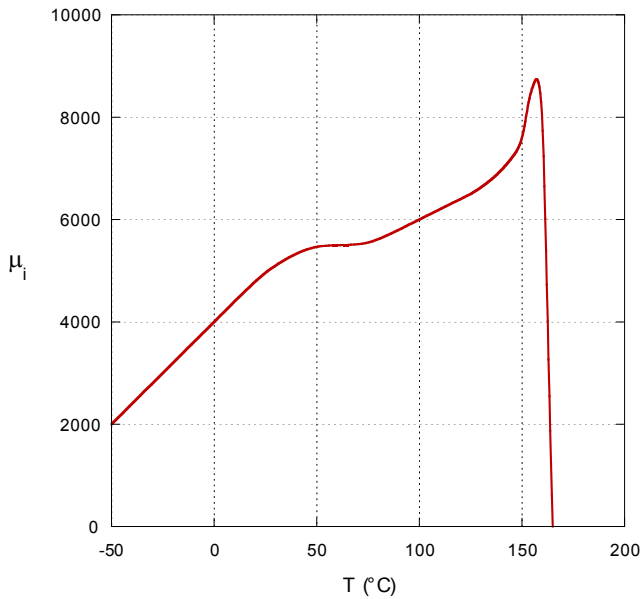

Permeability & Loss Factor vs. Frequency

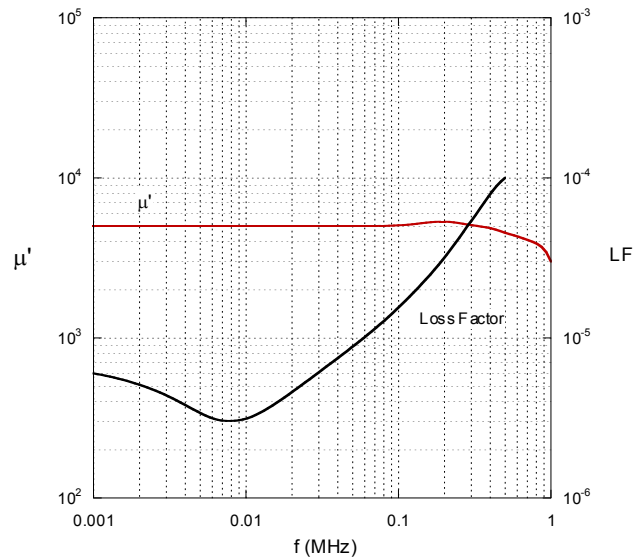

Comparing Turns - 35T0155-10P

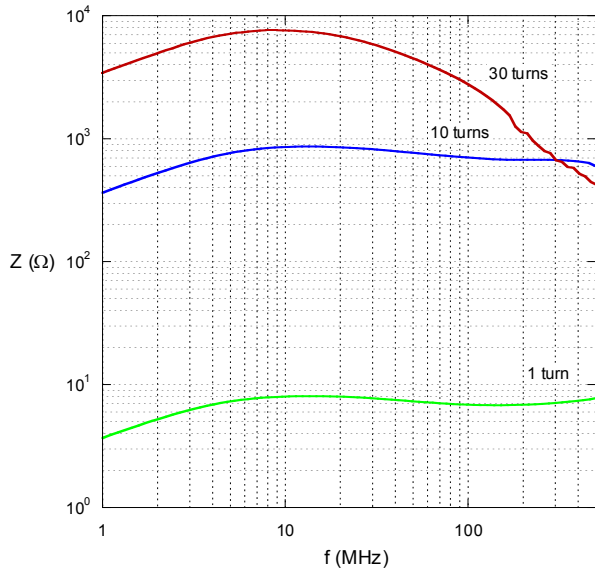

Saturation Flux Density vs. Temperature

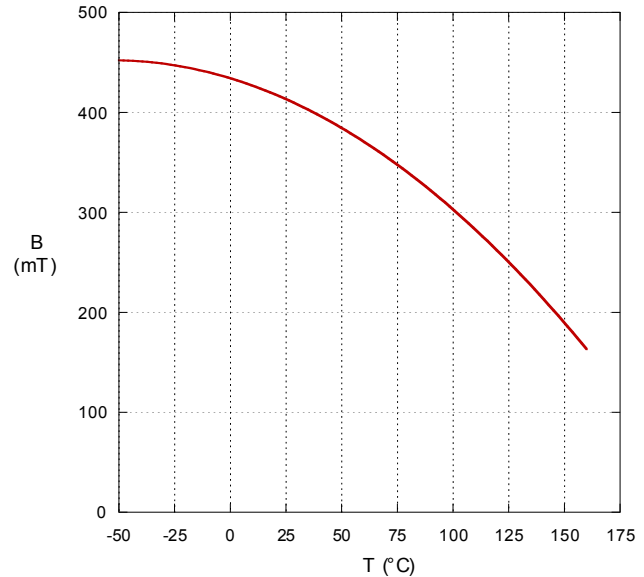

Material 28

Common Mode Mid Frequency

850 Permeability

Initial Permeability vs. Temperature

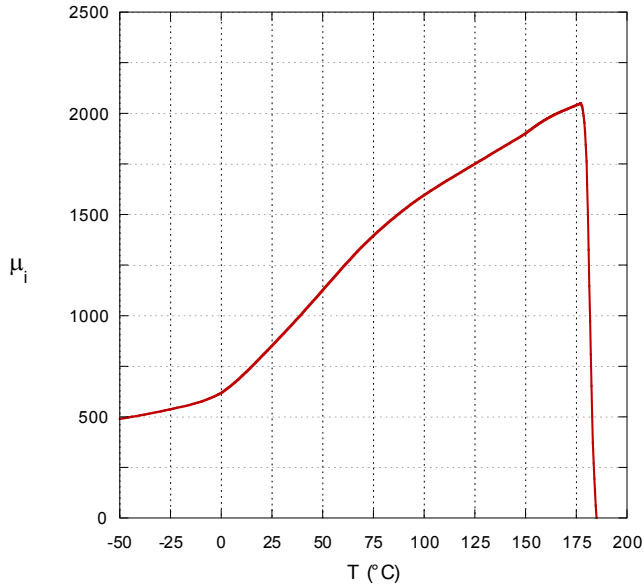

Permeability vs. Frequency

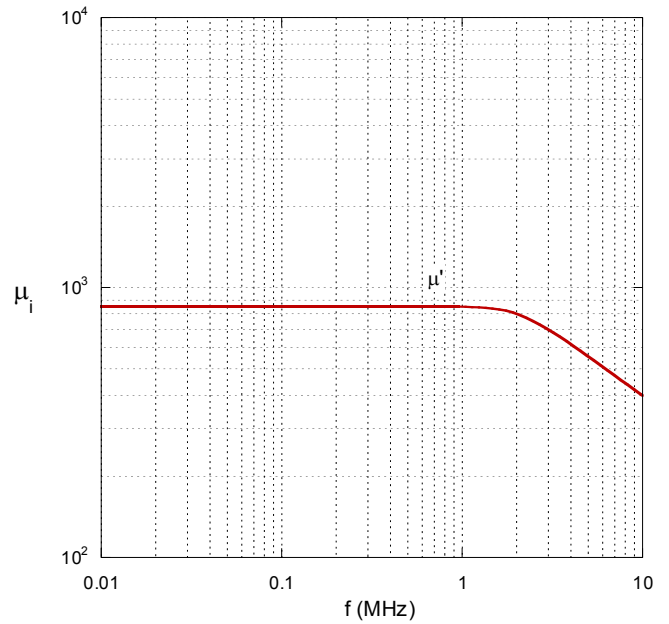

Comparing Turns - 28T0155-10P

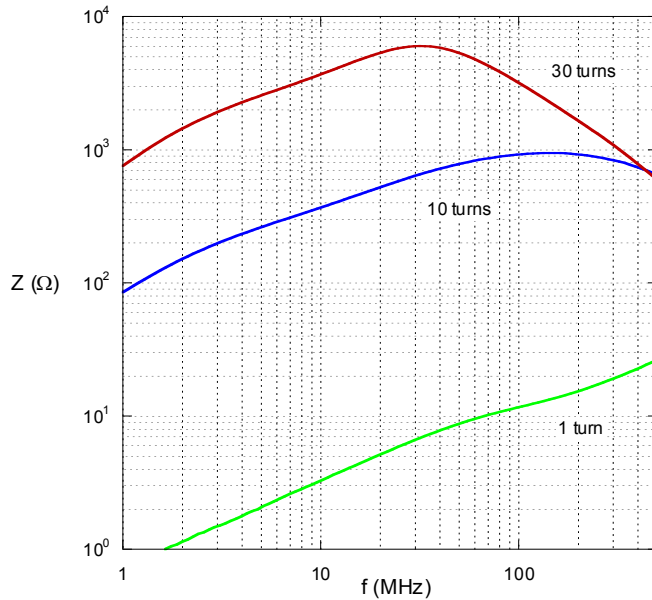

Saturation Flux Density vs. Temperature

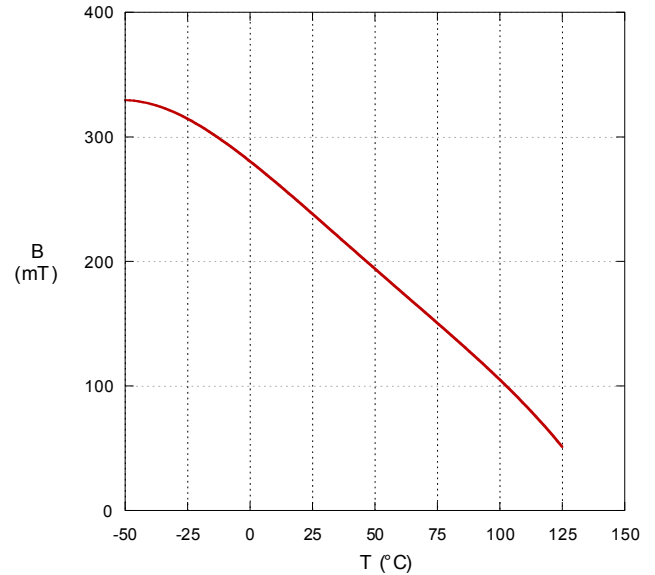

Please visit www.Steward.com for the most up-to-date information.

Material 25

Common Mode High Frequency

125 Permeability

Initial Permeability vs. Temperature

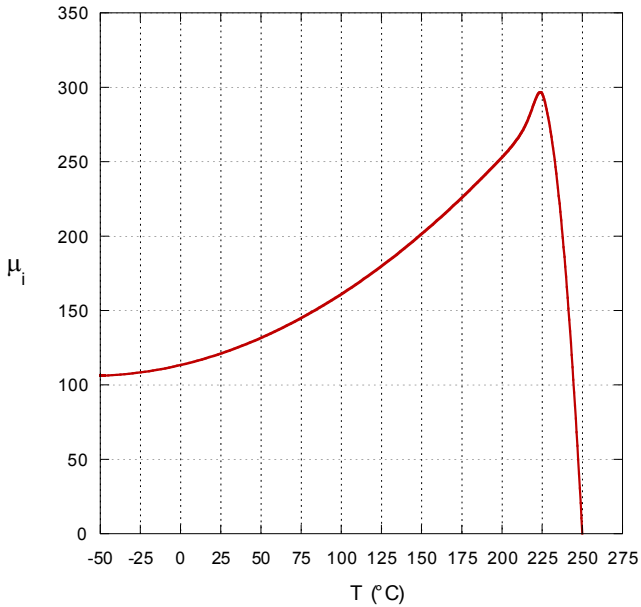

Permeability vs. Frequency

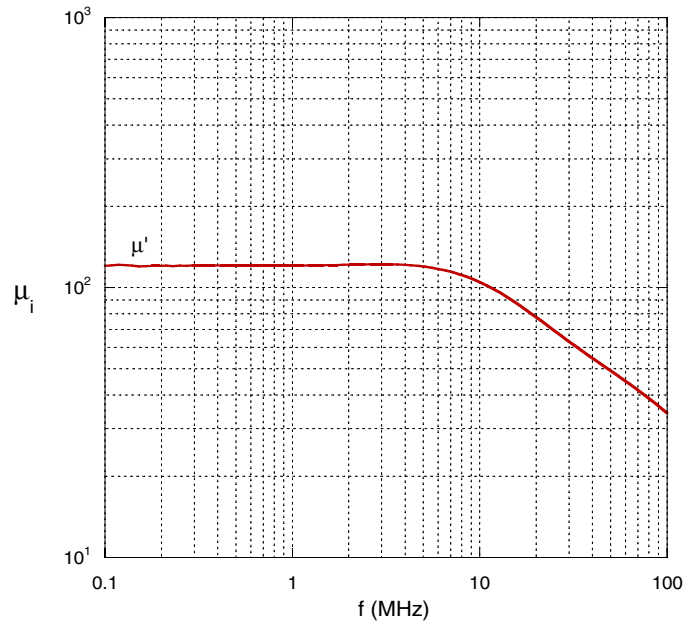

Comparing Turns - 25T0155-10P

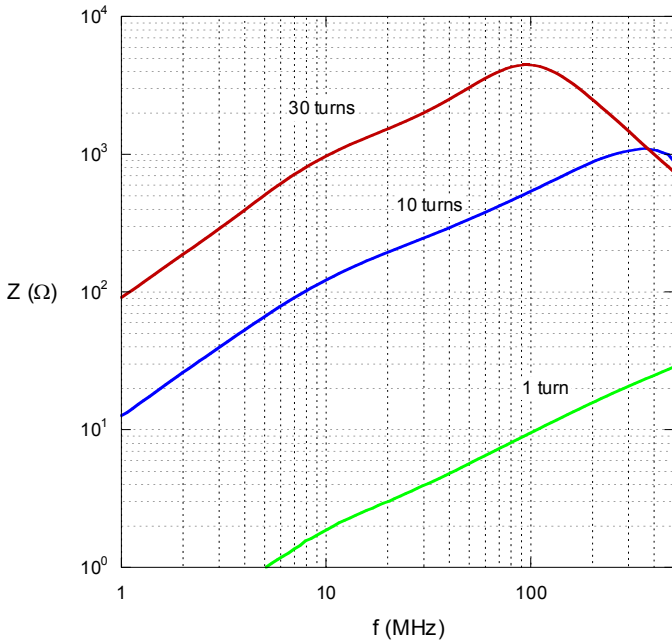

Saturation Flux Density vs. Temperature

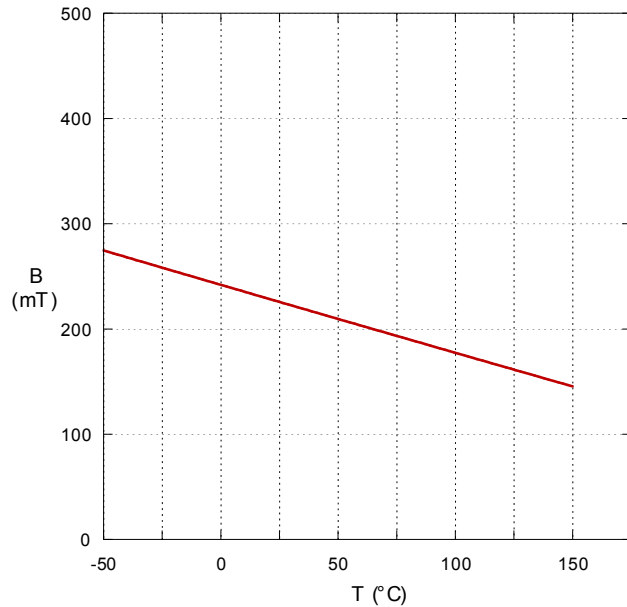

Material 38

Common Mode Broad Frequency

1,700 Permeability

Initial Permeability vs. Temperature

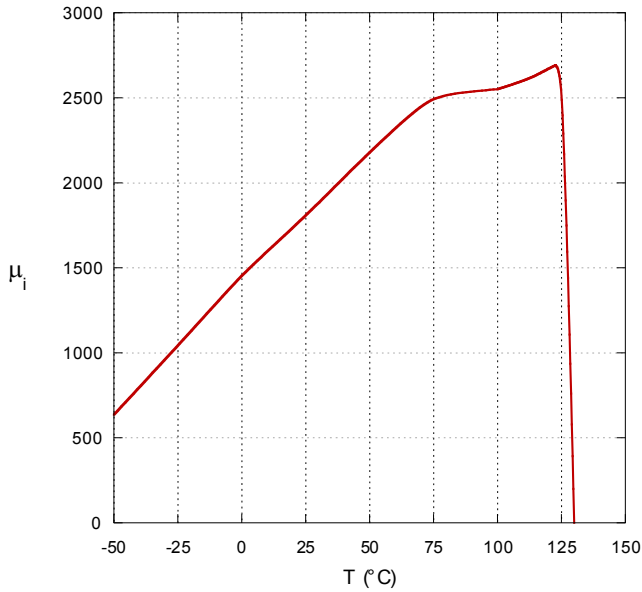

Permeability & Loss Factor vs. Frequency

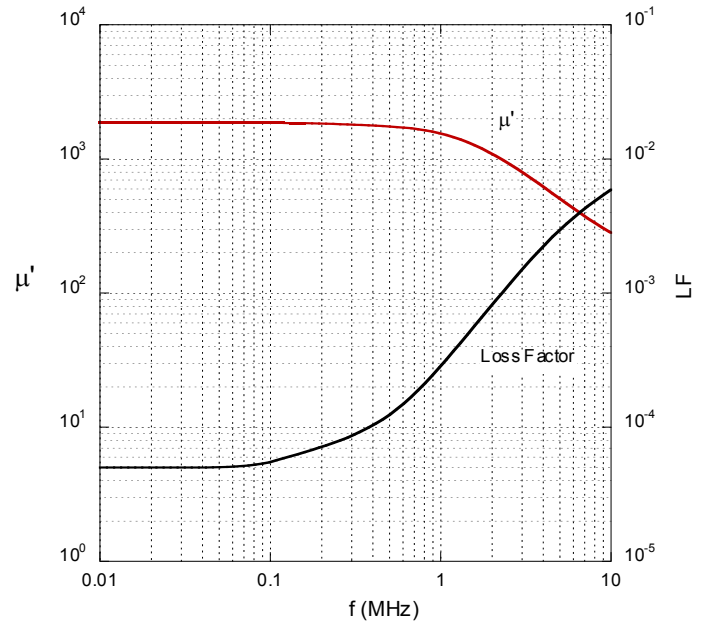

Comparing Turns - 38T0155-10P

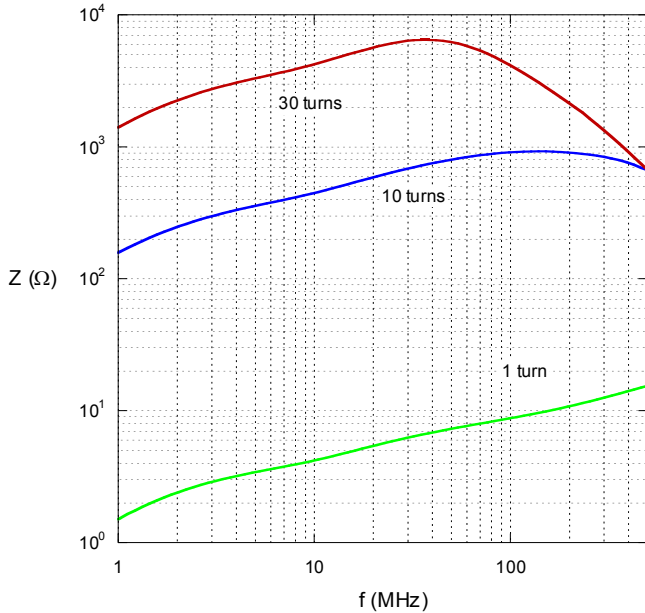

Saturation Flux Density vs. Temperature

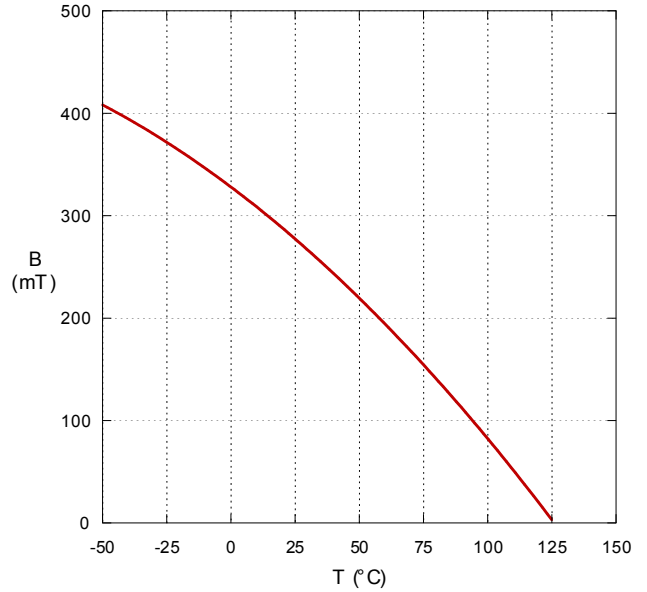

Please visit www.Steward.com for the most up-to-date information.

DC Bias Materials

46 / 36 / 56

TYPICAL VALUES			DC BIAS MATERIALS		
PARAMETER	SYMBOL	UNIT	36 DC Bias Standard Temp	46 DC Bias Extended Temp	56 Low DC Bias High Perm
Relative Initial Permeability	μ_i		4500	4000	5500
A_L Tolerance		%	± 25	± 25	± 25
Saturation FluxDensity	B_s	Gauss	4500	4500	4500
		mT	450	450	450
at Field Intensity	H	Oersteds	10	10	10
		A/m	800	800	800
Residual Flux Density	B_r	Gauss	1000	1000	1000
		mT	100	100	100
Coercive Force	H_c	Oersteds	0.10	0.10	0.10
		A/m	8	8	8
Relative Loss Factor at Frequency	$\tan \delta \mu_i$ f	10^{-6}	10	10	15
		MHz	0.10	0.10	0.10
Curie Temperature	T_c	$^{\circ}\text{C}$	> 150	> 150	> 130
Resistivity	ρ	$\Omega\text{-cm}$	10^2	10^2	10^2
Density		g/cm^3	4.8	4.8	4.8

Minimum A_L Values (nH/T ²)	DC Bias Standard Temp Material 36			DC Bias Extended Temp Material 46		
	A_L Target	A_L .35 Oe Bias Min		A_L Target	A_L .35 Oe Bias Min	
	25 $^{\circ}\text{C}$	25 $^{\circ}\text{C}$	0 $^{\circ}\text{C}$ to 70 $^{\circ}\text{C}$	25 $^{\circ}\text{C}$	25 $^{\circ}\text{C}$	-40 $^{\circ}\text{C}$ to 80 $^{\circ}\text{C}$
Part Numbers	25 $^{\circ}\text{C}$	25 $^{\circ}\text{C}$	0 $^{\circ}\text{C}$ to 70 $^{\circ}\text{C}$	25 $^{\circ}\text{C}$	25 $^{\circ}\text{C}$	-40 $^{\circ}\text{C}$ to 80 $^{\circ}\text{C}$
T0100-40	1188	1063	884	1056	1074	746
T0115-00	703	629	523	625	636	442
T0115-10	955	853	710	848	864	600
T0119-40	1501	1342	1117	1334	1358	943
T0120-80	739	661	550	657	668	464
T0122-30	988	883	735	878	894	621
T0135-10	912	815	679	811	825	573
T0153-60	818	731	608	727	740	514

Low DC Bias High Perm Material 56		
A_L Target	A_L .125 Oe Bias Min	
25 $^{\circ}\text{C}$	25 $^{\circ}\text{C}$	0 $^{\circ}\text{C}$ to 70 $^{\circ}\text{C}$
25 $^{\circ}\text{C}$	25 $^{\circ}\text{C}$	0 $^{\circ}\text{C}$ to 70 $^{\circ}\text{C}$
1452	1358	1074
860	804	636
1167	1091	863
1835	1718	1356
904	846	668
1208	1130	893
1115	1043	824
999	935	739

Comparing Materials

25°C Minimum Permeability

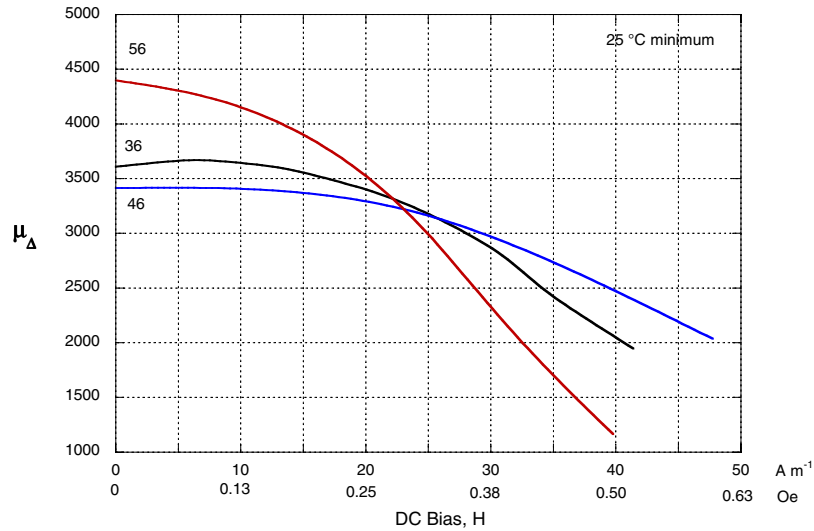

0°C to 70°C Minimum Permeability

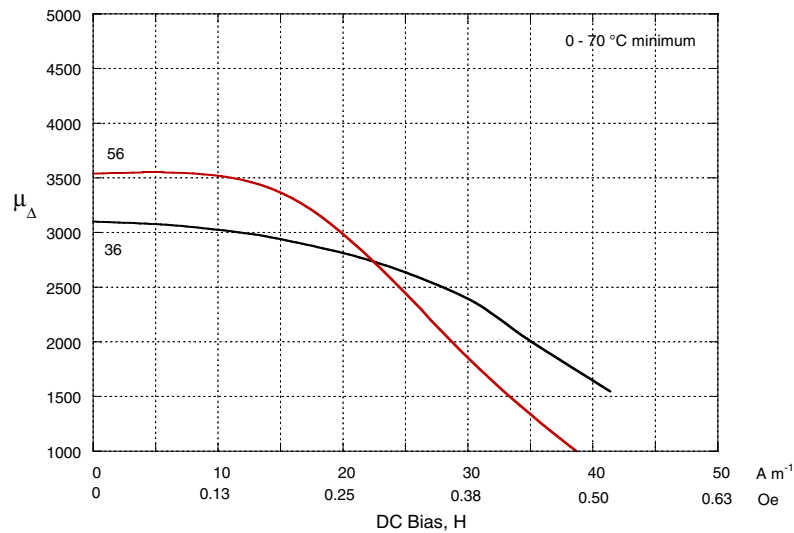

-40°C to 85°C Minimum Permeability

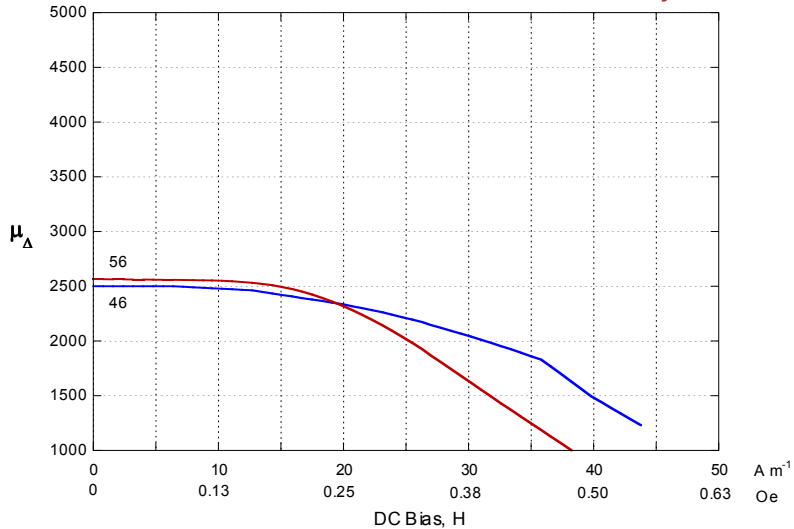

Please visit www.Steward.com for the most up-to-date information.

Material 36

DC Bias Standard Temperature (0°C to 70°C)

4,500 Permeability

Initial Permeability vs. Temperature

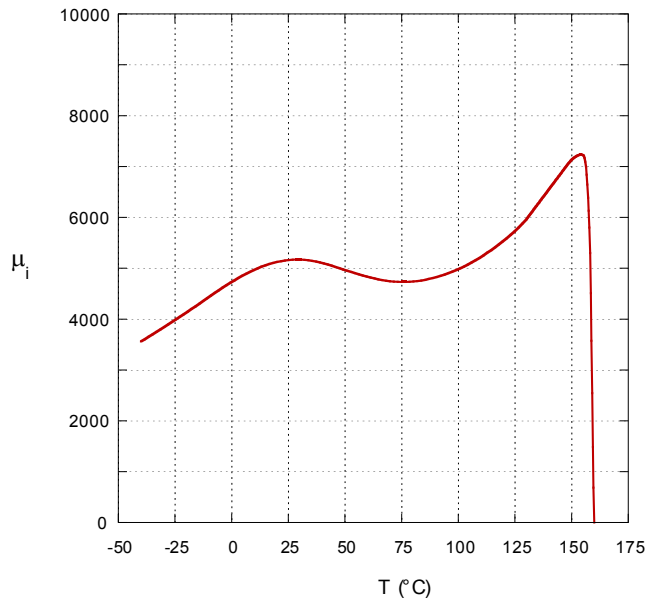

Amplitude Permeability vs. Flux Density

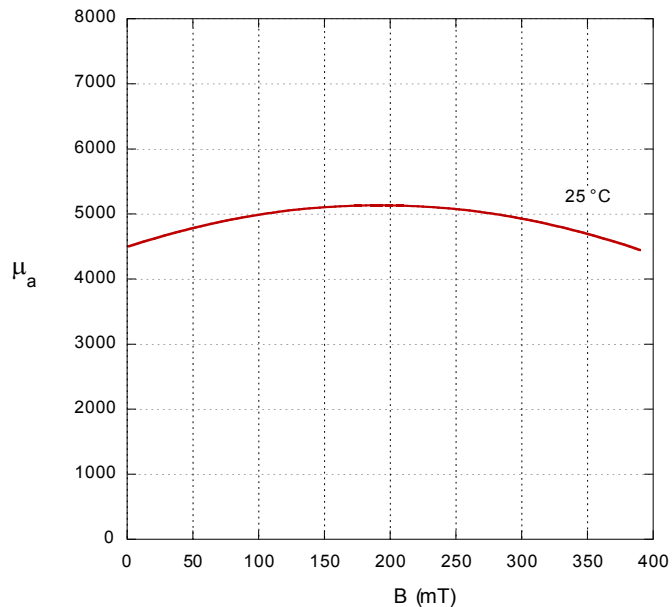

Incremental Permeability vs. Field Intensity

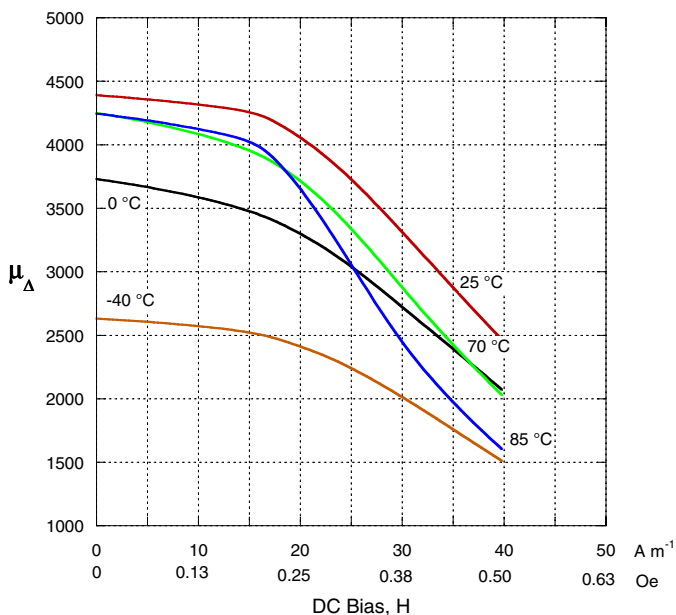

Permeability & Loss Factor vs. Frequency

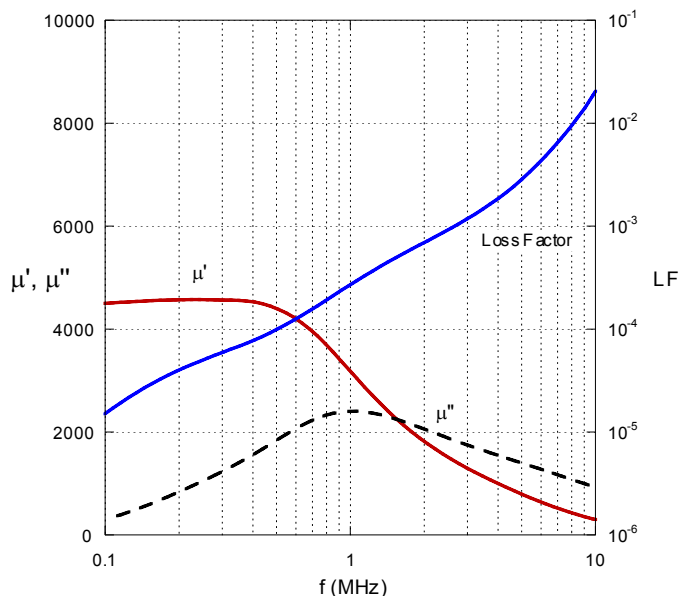

Material 46

DC Bias Extended Temperature (-40°C to 85°C) 4,000 Permeability

Initial Permeability vs. Temperature

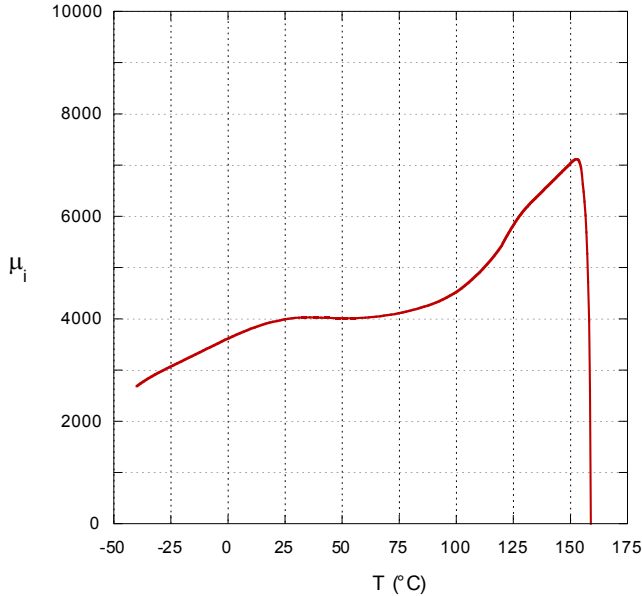

Amplitude Permeability vs. Flux Density

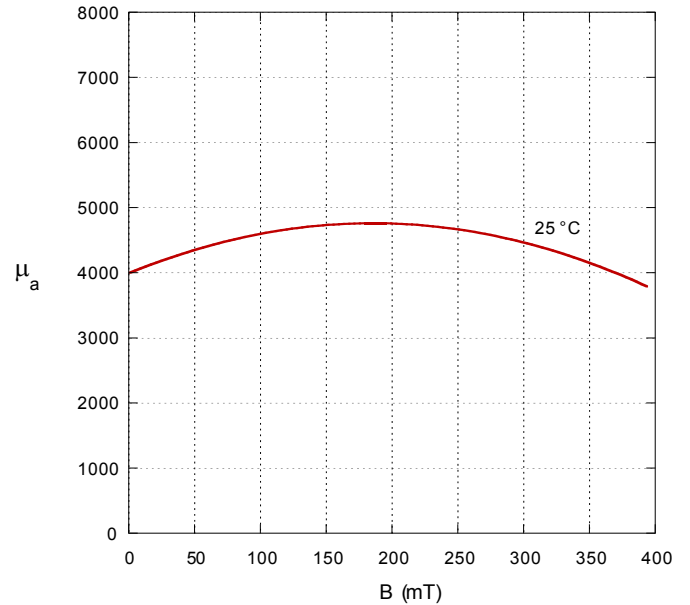

Incremental Permeability vs. Field Intensity

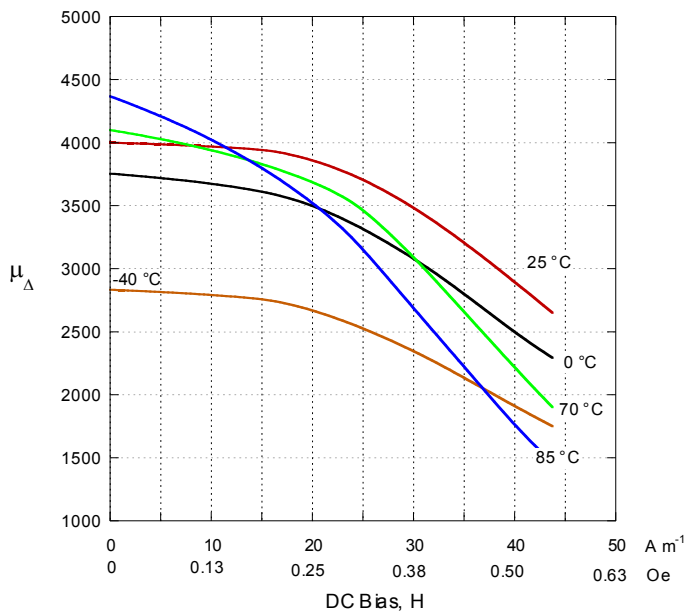

Permeability & Loss Factor vs. Frequency

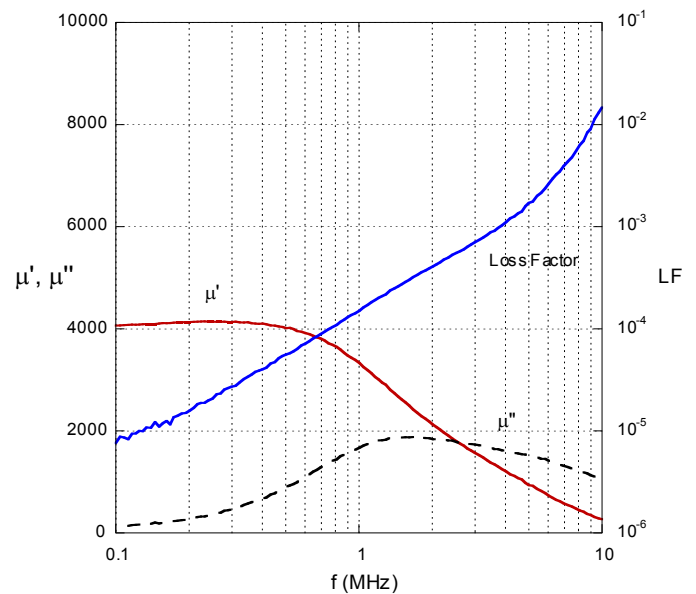

Please visit www.Steward.com for the most up-to-date information.

Material 56

Low DC Bias - High Permeability

5,500 Permeability

Initial Permeability vs. Temperature

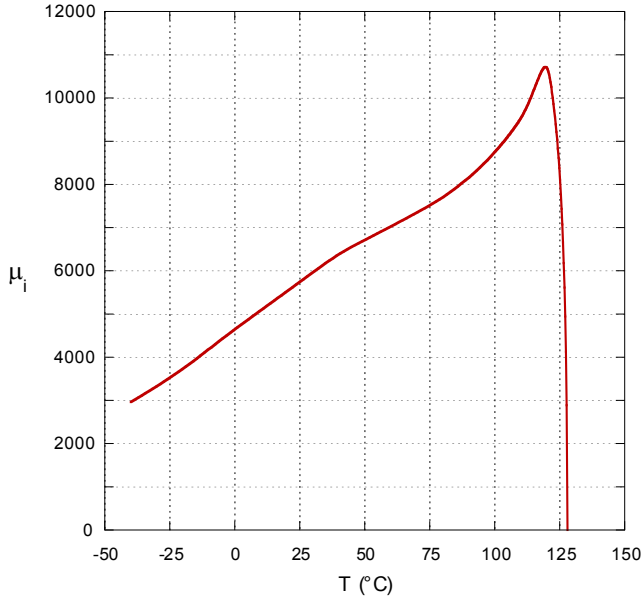

Amplitude Permeability vs. Flux Density

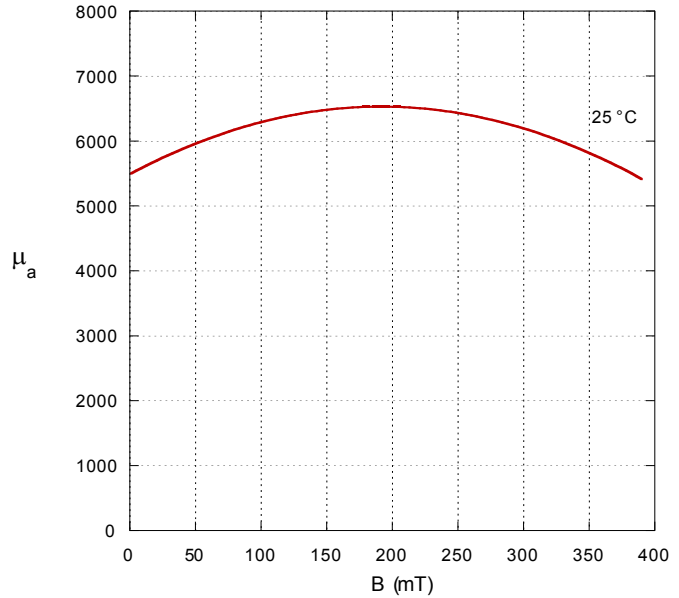

Incremental Permeability vs. Field Intensity

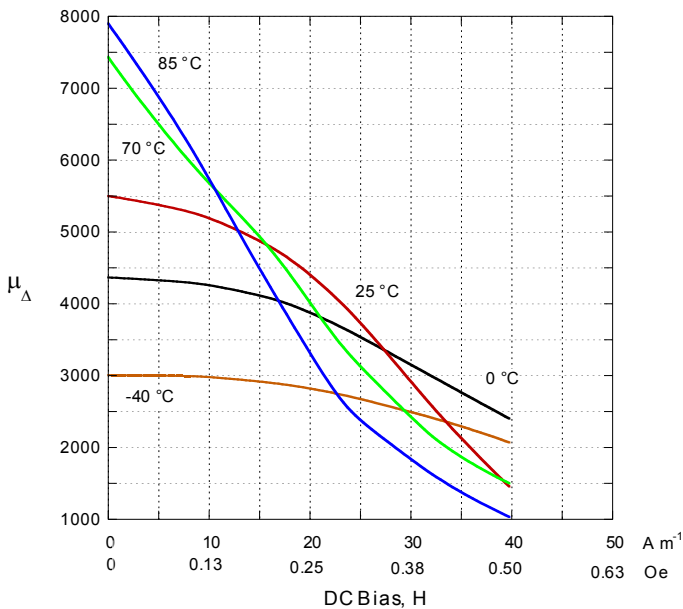

Permeability & Loss Factor vs. Frequency

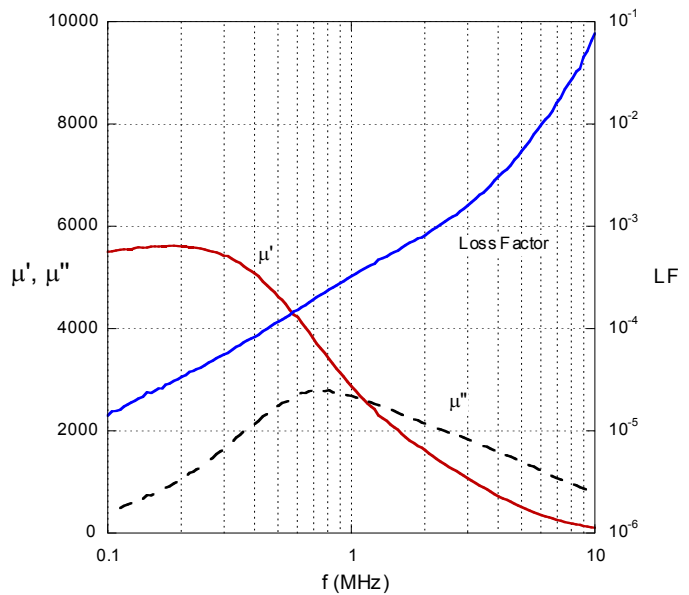

Material 36/46 Minimum Inductance with Various Turns (8 mA DC Bias)

Part	16 turns					18 turns					20 turns					22 turns						
	H (Oh)		25 C		0-70 C		25 C		0-70 C		25 C		0-70 C		25 C		0-70 C		25 C		0-85 C	
	36	46	36	46	36	46	36	46	36	46	36	46	36	46	36	46	36	46	36	46		
100-2	0.29	89	73	295	245	291	204	0.33	106	88	355	295	356	248	0.36	125	105	418	348	427	295	
100-4	0.29	295	245	291	204	0.33	355	295	356	248	0.36	418	348	427	295	0.40	466	389	493	433	338	
115-0	0.24	183	151	177	125	0.27	226	187	220	155	0.30	270	224	267	187	0.33	314	261	315	219	219	
115-1	0.24	249	206	240	170	0.27	307	254	299	211	0.30	367	304	362	253	0.33	426	354	428	297	297	
119-4	0.27	381	316	372	262	0.30	467	387	461	323	0.34	546	453	551	382	0.37	628	524	646	445	445	
120-8	0.22	195	161	187	133	0.25	242	200	234	166	0.28	290	240	284	200	0.31	339	281	337	235	235	
121-2	0.24	--	--	214	152	0.27	--	--	267	188	0.30	--	--	323	226	0.33	--	--	381	265	265	
122-3	0.23	259	214	249	177	0.26	321	266	311	220	0.29	384	318	378	265	0.32	447	371	446	311	311	
135-0	0.21	150	124	143	102	0.24	186	152	179	127	0.26	226	187	219	155	0.29	285	219	280	183	183	
135-1	0.21	243	201	232	166	0.24	301	249	290	206	0.26	366	303	355	251	0.29	429	355	422	296	296	
135-2	0.21	102	84	--	--	0.24	126	104	--	--	0.26	154	127	--	--	0.29	180	149	--	--	--	
135-4	0.21	210	173	--	--	0.24	260	215	--	--	0.26	316	262	--	--	0.29	370	307	--	--	--	
135-6	0.21	180	149	--	--	0.24	223	184	--	--	0.26	271	224	--	--	0.29	318	263	--	--	--	
137-0	0.23	109	90	--	--	0.26	136	112	--	--	0.29	162	134	--	--	0.32	189	157	--	--	--	
145-0	0.21	--	--	350	250	0.24	--	--	438	310	0.27	--	--	532	375	0.29	--	--	636	446	446	
153-0	0.20	183	151	--	--	0.22	228	188	--	--	0.25	275	228	--	--	0.27	327	271	--	--	--	
153-4	0.20	365	302	--	--	0.22	456	377	--	--	0.25	551	455	--	--	0.27	655	542	--	--	--	

Part	24 turns					28 turns					30 turns					36 turns						
	H (Oh)		25 C		0-70 C		25 C		0-70 C		25 C		0-70 C		25 C		0-70 C		25 C		0-85 C	
	36	46	36	46	36	46	36	46	36	46	36	46	36	46	36	46	36	46	36	46		
100-2	0.44	147	122	489	407	555	378	0.51	166	133	554	443	674	398	0.55	--	--	655	506	687	466	
100-4	0.44	489	407	555	378	0.51	554	443	674	398	0.55	655	506	687	466	0.45	442	365	496	687	466	
115-0	0.36	356	297	364	251	0.39	397	333	413	283	0.42	418	348	460	314	0.45	442	365	496	687	466	
115-1	0.36	484	403	494	341	0.39	539	451	560	385	0.42	567	472	625	427	0.45	589	496	665	994	599	
119-4	0.40	700	585	741	508	0.44	725	603	823	560	0.47	780	639	911	592	0.50	826	665	994	599	599	
120-8	0.33	392	326	394	274	0.36	440	366	449	310	0.39	484	405	503	345	0.42	504	420	556	379	379	
121-2	0.36	--	--	441	304	0.39	--	--	500	343	0.42	--	--	557	381	0.45	--	--	612	416	416	
122-3	0.35	509	423	517	357	0.38	568	475	587	404	0.41	607	507	656	448	0.43	651	541	732	499	499	
135-0	0.32	303	252	303	211	0.34	346	287	349	242	0.37	382	319	382	270	0.40	410	343	435	298	298	
135-1	0.32	491	407	490	342	0.34	560	466	565	392	0.37	618	516	636	438	0.40	665	555	704	482	482	
135-2	0.32	206	171	--	--	0.34	235	195	--	--	0.37	260	217	--	--	0.40	279	233	--	--	--	
135-4	0.32	424	352	--	--	0.34	484	402	--	--	0.37	534	446	--	--	0.40	574	480	--	--	--	
135-6	0.32	364	302	--	--	0.34	415	345	--	--	0.37	458	382	--	--	0.40	492	411	--	--	--	
137-0	0.35	215	179	--	--	0.37	244	203	--	--	0.40	285	221	--	--	0.43	275	228	--	--	--	
145-0	0.32	--	--	740	515	0.35	--	--	844	584	0.37	--	--	959	661	0.40	--	--	1062	727	727	
153-0	0.30	377	312	--	--	0.32	430	357	--	--	0.35	478	397	--	--	0.37	530	443	--	--	--	
153-4	0.30	754	625	--	--	0.32	861	715	--	--	0.35	955	795	--	--	0.37	1061	885	--	--	--	

Part	32 turns					34 turns					36 turns					38 turns						
	H (Oh)		25 C		0-70 C		25 C		0-70 C		25 C		0-70 C		25 C		0-70 C		25 C		0-85 C	
	36	46	36	46	36	46	36	46	36	46	36	46	36	46	36	46	36	46	36	46		
100-2	0.58	--	--	--	--	0.62	--	--	--	--	0.65	--	--	--	--	0.68	--	--	--	--	--	
100-4	0.58	--	--	--	--	0.62	--	--	--	--	0.65	--	--	--	--	0.68	--	--	--	--	--	
115-0	0.48	465	379	549	348	0.51	483	386	588	348	0.54	--	--	623	346	0.57	--	--	--	--	--	
115-1	0.48	631	514	744	472	0.51	656	525	798	472	0.54	--	--	846	470	0.57	--	--	--	--	--	
119-4	0.54	--	--	1051	584	0.57	--	--	--	--	0.60	--	--	--	--	0.64	--	--	--	--	--	
120-8	0.45	528	437	605	410	0.47	587	464	662	430	0.50	586	472	705	425	0.53	--	--	744	423	423	
121-2	0.48	--	--	664	421	0.51	--	--	712	421	0.55	--	--	740	402	0.58	--	--	--	--	--	
122-3	0.46	689	567	796	529	0.45	718	582	855	529	0.52	739	587	909	527	0.55	--	--	956	520	520	
135-0	0.42	437	364	481	329	0.45	454	376	520	353	0.47	484	396	565	367	0.50	497	400	588	360	360	
135-1	0.42	708	589	780	533	0.45	736	608	843	572	0.47	784	642	915	595	0.50	805	648	989	584	584	
135-2	0.42	297	247	--	--	0.45	309	255	--	--	0.47	329	270	--	--	0.50	338	272	--	--	--	
135-4	0.42	612	509	--	--	0.45	636	526	--	--	0.47	678	555	--	--	0.50	696	560	--	--	--	
135-6	0.42	524	437	--	--	0.45	545	451	--	--	0.47	581	476	--	--	0.50	597	480	--	--	--	
137-0	0.46	291	239	--	--	0.49	303	246	--	--	0.52	312	248	--	--	0.55	--	--	--	--	--	
145-0	0.43	--	--	1160	790	0.45	--	--	1271	862	0.48	--	--	1358	862	0.51	--	--	1436	849	849	
153-0	0.40	565	472	--	--	0.42	597	497	--	--	0.45	616	510	--	--	0.47	653	534	--	--	--	
153-4	0.40	1130	944	--	--	0.42	1194	994	--	--	0.45	1232	1019	--	--	0.47	1305	1069	--	--	--	

Part	36 turns					38 turns					40 turns					42 turns						
	H (Oh)		25 C		0-70 C		25 C		0-70 C		25 C		0-70 C		25 C		0-70 C		25 C		0-85 C	
	36	46	36	46	36	46	36	46	36	46	36	46	36	46	36	46	36	46	36	46		
100-2	0.40	140	117	466	389	493	338	0.45	166	133	554	443	674	398	0.51	166	133	554	443	674	398	
100-4	0.40	466	389	493	338	0.45	554	443	674	398	0.51	655	506	687	466	0.45	442	365	496	687	466	
115-0	0.33	314	261	315	219	0.30	270	224	267	187	0.33	314	261	315	219	0.36	367	304	362	253	253	
115-1	0.33	426	354	428	297	0.30	467	387	461	323	0.33	511	428	511	323	0.36	565	482	565	382	382	
119-4	0.37	628	524	646	445	0.34	674	551	705	445	0.37	744	623	798	445	0.40	826	665	994	599	599	
120-8	0.31	339	281	337	235	0.28	384	318	378	265	0.30	429	355	422	296	0.32	478	397	478	296	296	
121-2	0.33	--	--	381	265	0.33	--	--	446	311	0.36	--	--	532	375	0.39	--	--	636	446	446	
122-3	0.32	447	371	446	311	0.32	492	411	492	311	0.35	511	428	511	323	0.38	532	446	532	311	311	
135-0	0.29	285	219	280	183	0.26	321	266	311	220	0.28	366	303	355	251	0.30	410	343	435	298	298	
135-1	0.29	429	355	422	296	0.26	478	397	478	296	0.28	511	428	511	323	0.30	554	443	674	398	398	
135-2	0.29	180	149	--	--	0.26																

High Permeability Materials

For Telecom & Low Frequency Filtering

42 / 40

PARAMETER	SYMBOL	UNIT	42	40
Relative Initial Permeability	μ_i		7500	10000
A_L Tolerance		%	± 25	± 30
Saturation Flux Density	B_s	Gauss	4100	3800
		mT	410	380
at Field Intensity	H	Oersteds	10	10
		A/m	800	800
Residual Flux Density	B_r	Gauss	1100	1400
		mT	110	140
Coercive Force	H_c	Oersteds	0.10	0.04
		A/m	8	3
Relative Loss Factor	$\tan \delta \mu_i$	10^{-6}	6	5
at Frequency	f	MHz	0.010	0.10
Curie Temperature	T_c	$^{\circ}\text{C}$	> 130	> 120
Resistivity	ρ	$\Omega\text{-cm}$	10	1
Density		g/cm^3	4.8	4.8

Permeability vs. Temperature

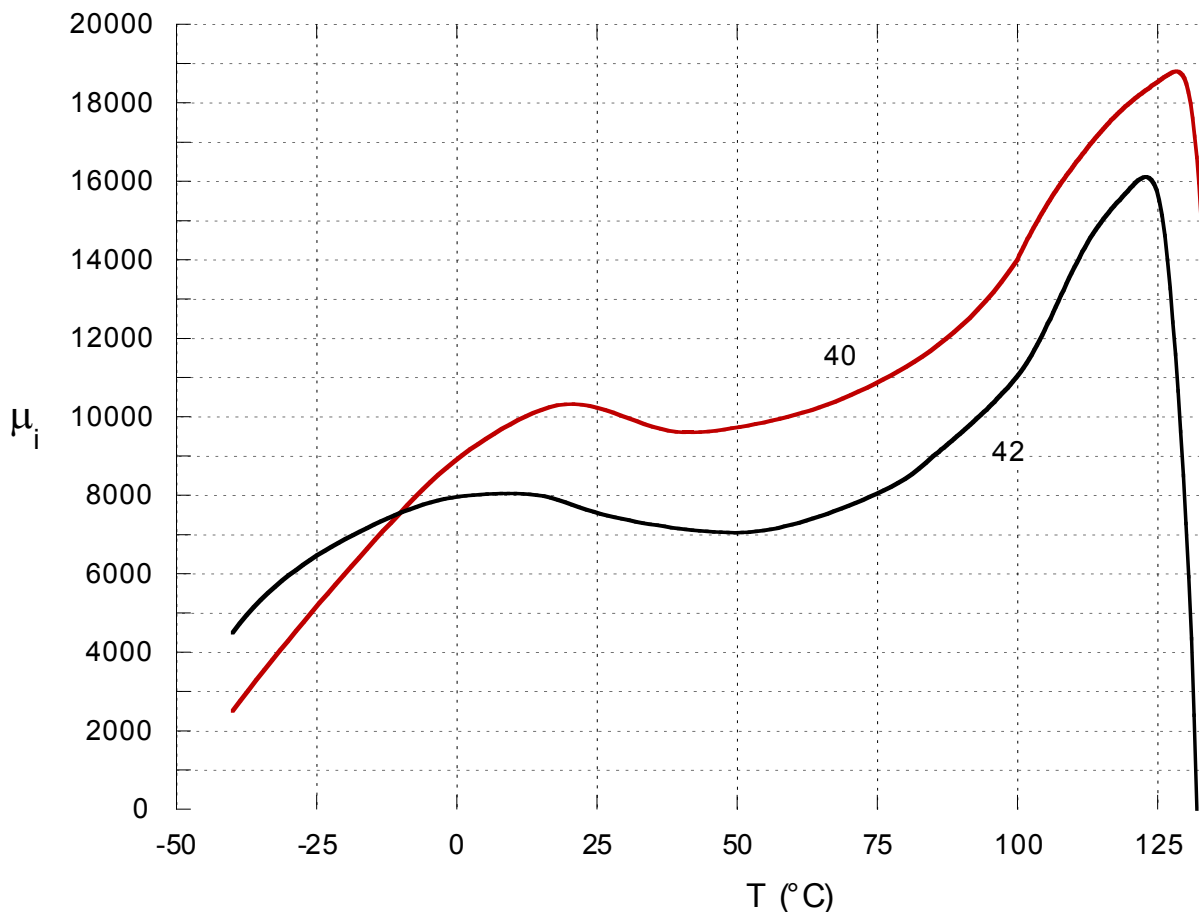

Part Number	Material 40	Material 42	
	High Permeability	Broad Temperature	
	10,000 Nominal Perm	7500 Nominal Perm	3000 Minimum Perm
	A_L @ 100 KHz (nH/T ²)	A_L @ 25°C (nH/T ²)	A_L @ -40°C to 85°C (nH/T ²)
*T0100-20P	1056	792	317
*T0119-00P	2224	1688	667
*T0135-10P	2703	2027	811
*T0155-00P	2876	2157	863
*T0231-10P	3966	2974	1190
*T0238-00P	4564	3422	1369
*T0301-00P	8361	6270	2508
*T0325-00P	5912	4434	1774

Please visit www.Steward.com for the most up-to-date information.

Material 42

Telecom Broad Temperature

7,500 Permeability

Initial Permeability vs. Temperature

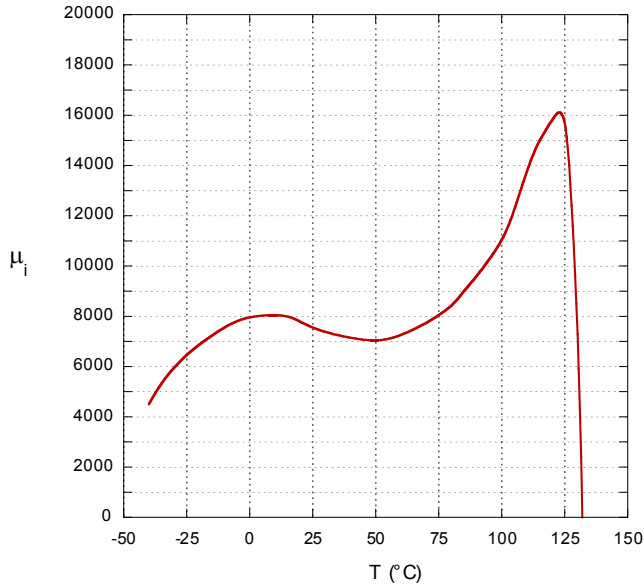

Permeability & Loss Factor vs. Frequency

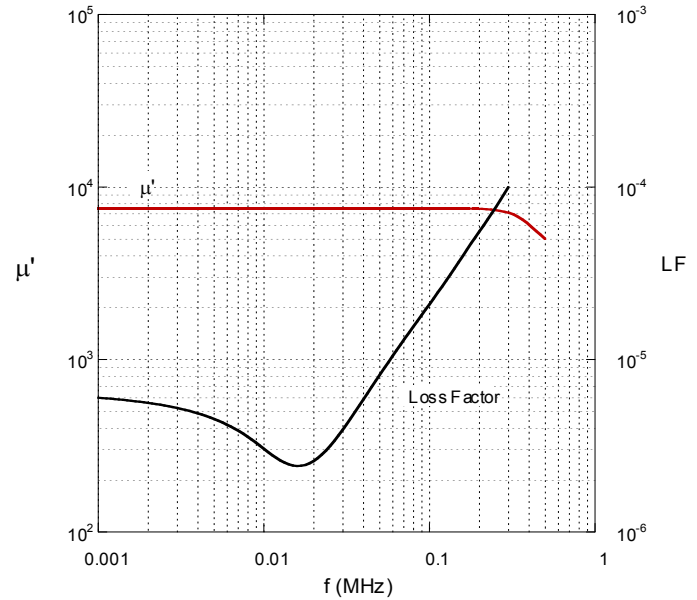

Amplitude Permeability

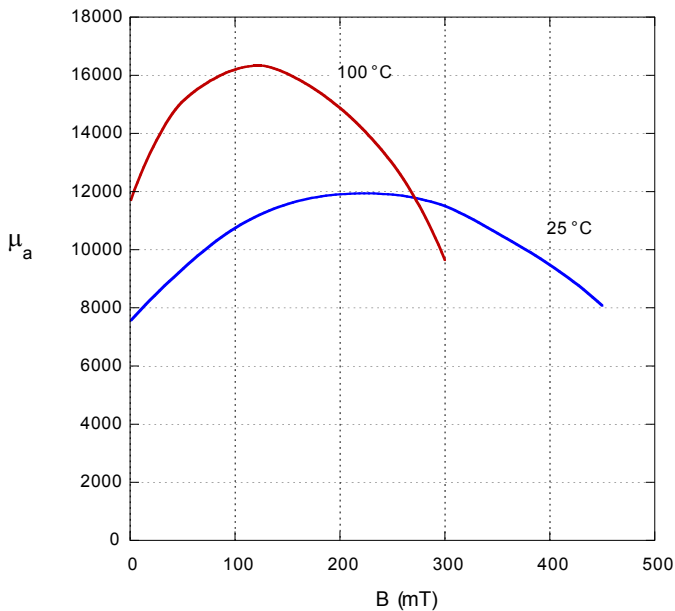

Saturation Flux Density vs. Temperature

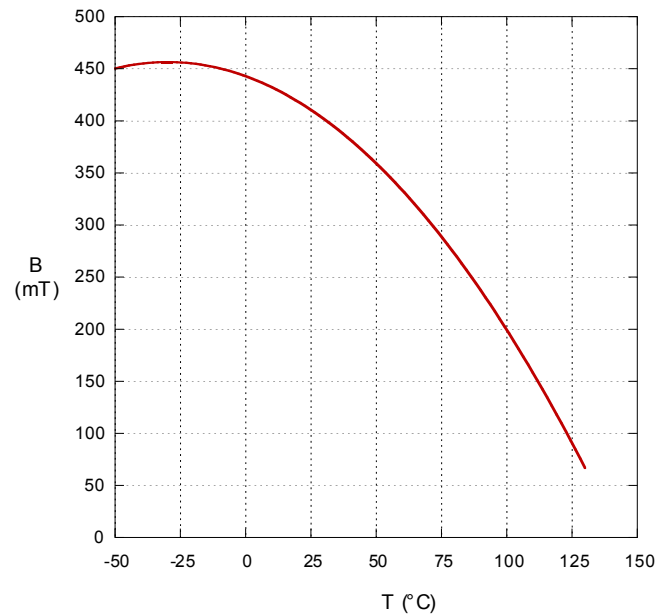

Material 40

Telecom High Permeability

10,000 Permeability

Initial Permeability vs. Temperature

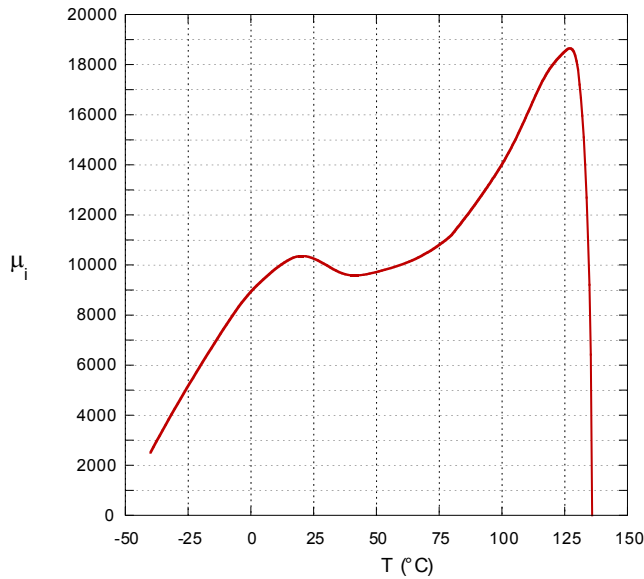

Permeability & Loss Factor vs. Frequency

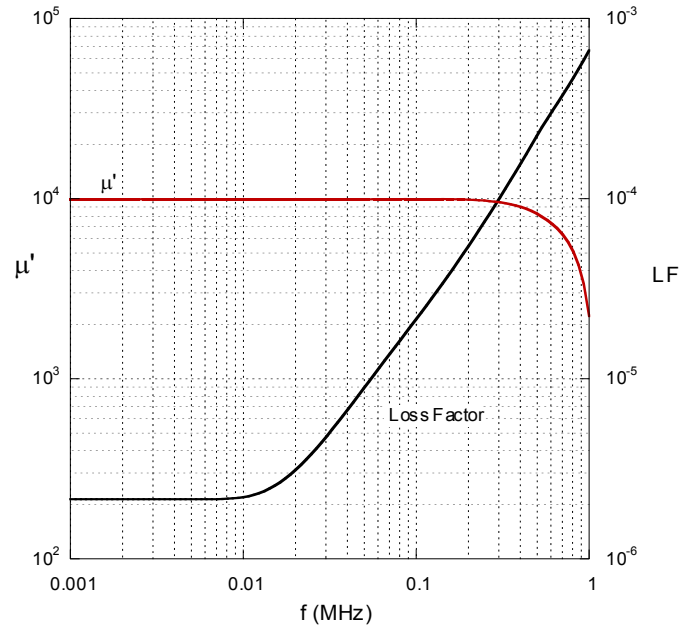

Amplitude Permeability

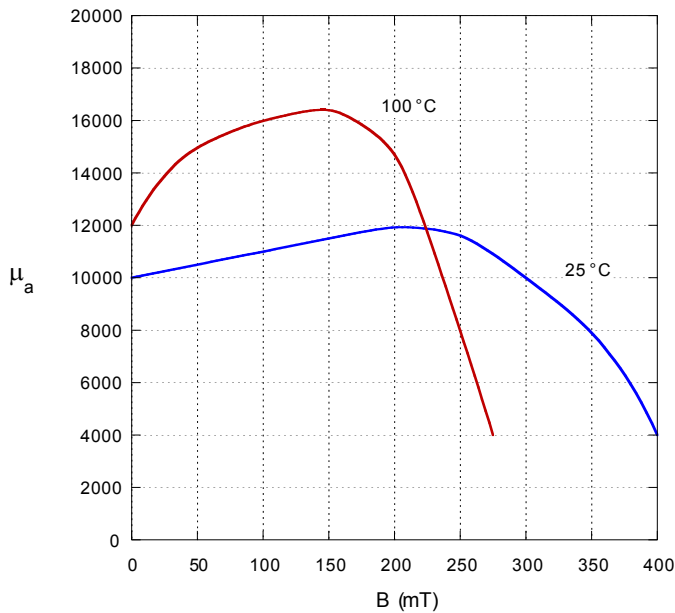

Saturation Flux Density vs. Temperature

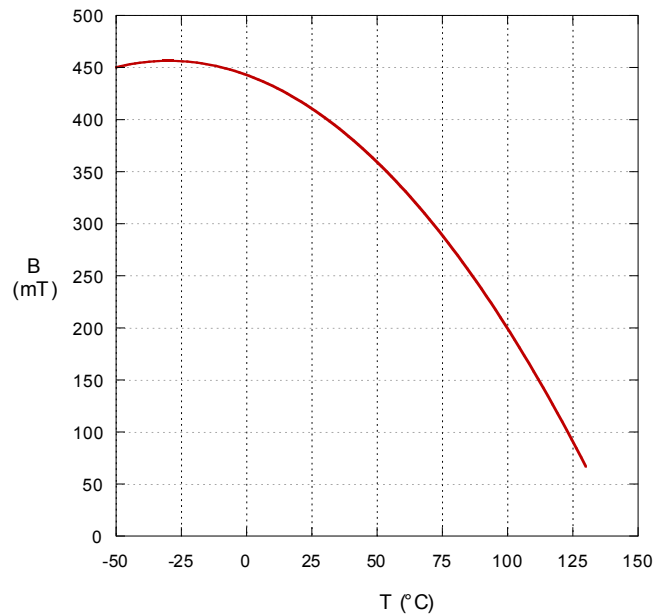

Please visit www.Steward.com for the most up-to-date information.

Other Materials

35 / 39

PARAMETER	SYMBOL	UNIT	35	39
Relative Initial Permeability	μ_i		5000	7000
A_L Tolerance		%	± 20	± 25
Saturation Flux Density	B_s	Gauss	4500	3800
		mT	450	380
at Field Intensity	H	Oersteds	10	12.5
		A/m	800	1000
Residual Flux Density	B_r	Gauss	1000	730
		mT	100	73
Coercive Force	H_c	Oersteds	0.10	0.10
		A/m	8	8
Relative Loss Factor	$\tan \delta \mu_i$	10^{-6}	≤ 20	≤ 8
at Frequency	f	MHz	0.100	0.010
Curie Temperature	T_c	$^{\circ}\text{C}$	> 150	> 130
Resistivity	ρ	$\Omega\text{-cm}$	100	35
Density		g/cm^3	4.8	4.9

Material 35

5,000 Permeability

Initial Permeability vs. Temperature

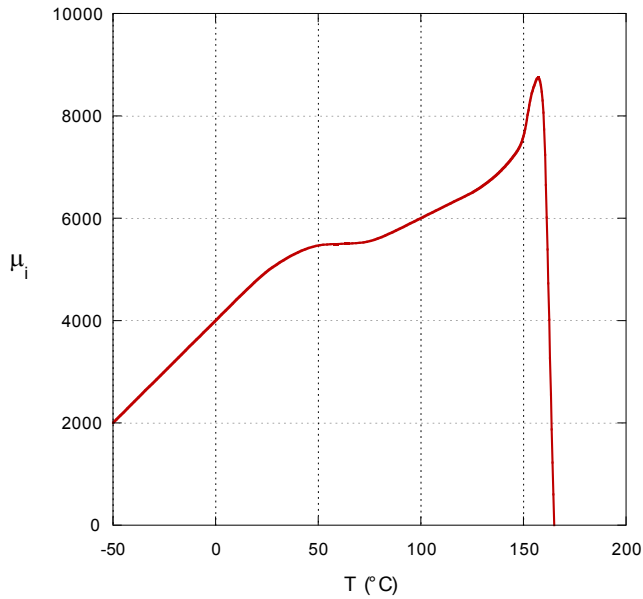

Permeability & Loss Factor vs. Frequency

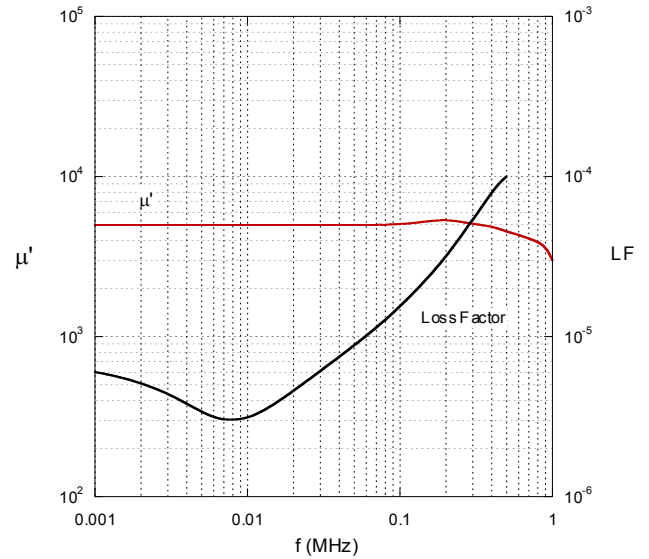

Amplitude Permeability vs. Flux Density

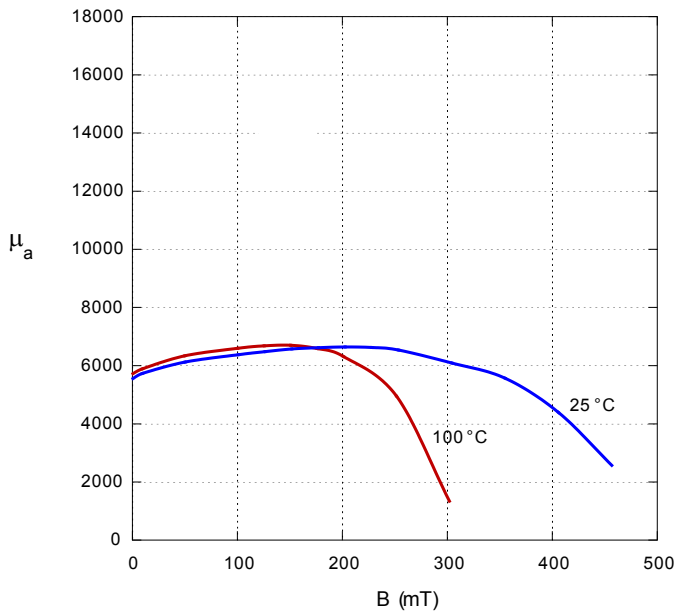

Saturation Flux Density vs. Temperature

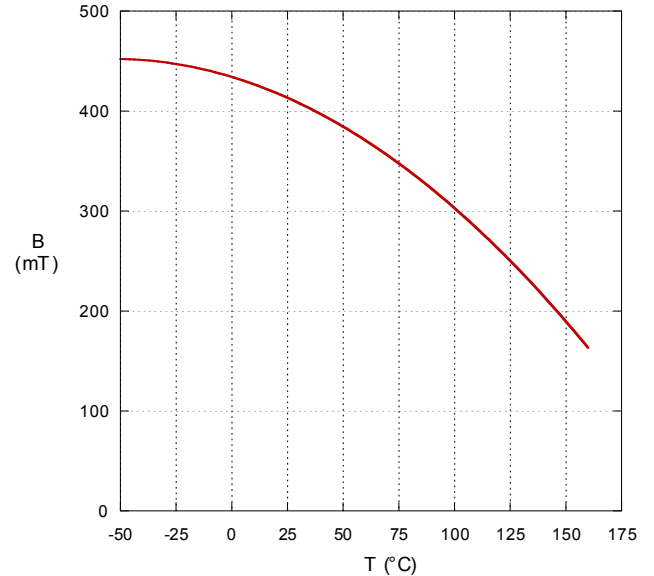

Please visit www.Steward.com for the most up-to-date information.

Material 39

7,000 Permeability

Initial Permeability vs. Temperature

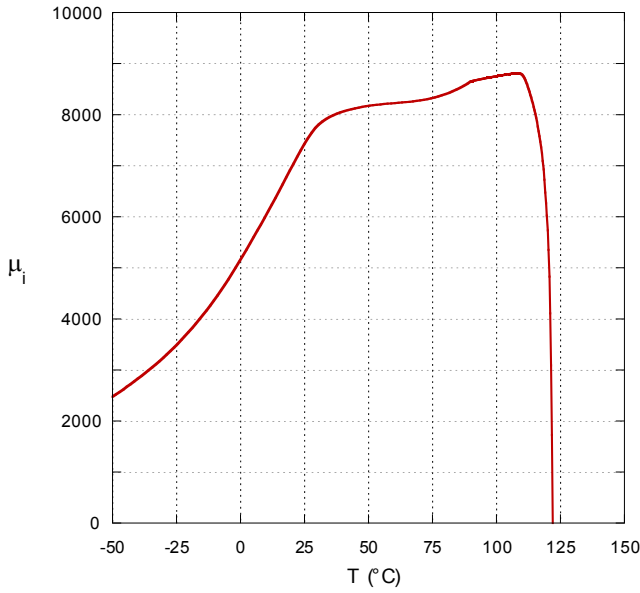

Permeability & Loss Factor vs. Frequency

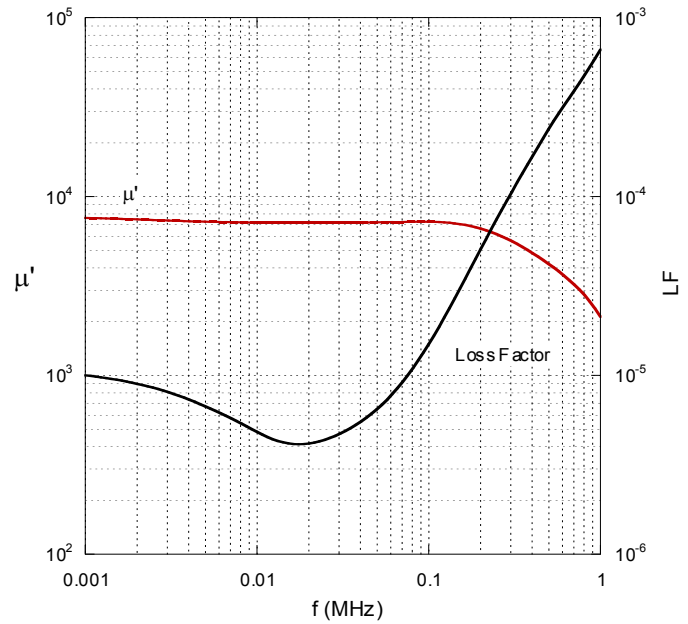

Amplitude Permeability vs. Flux Density

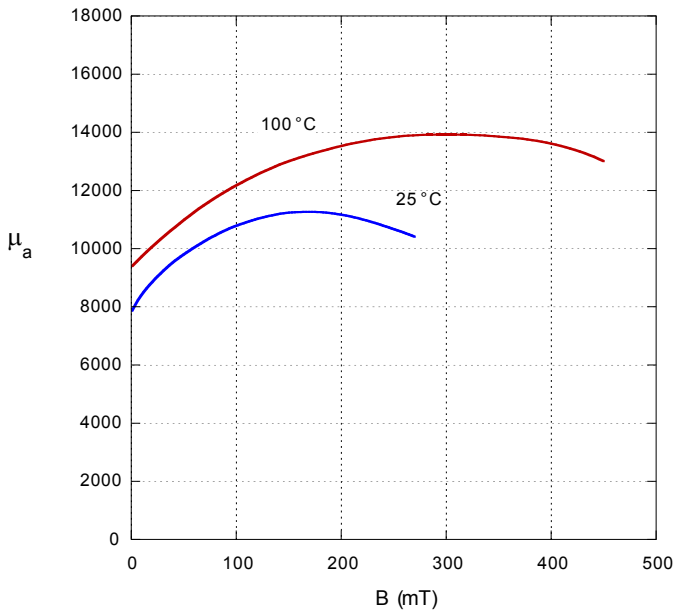

Saturation Flux Density vs. Temperature

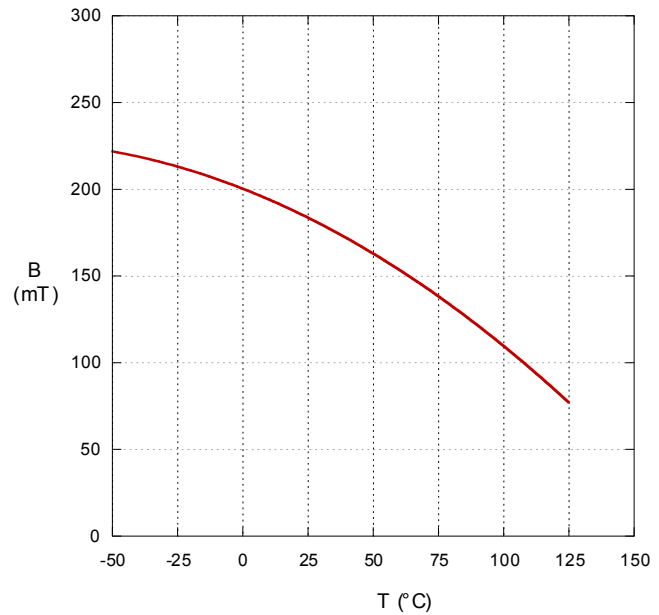

MATERIALS

PARAMETER	SYMBOL	UNIT	25	28	38	46	36	35	56	39	42	40
Relative Initial Permeability	μ_i		125	850	1700	4000	4500	5000	5500	7000	7500	10000
Tolerance		%	± 30	± 20	± 30	± 25	± 25	± 20	± 25	± 25	± 25	± 30
Saturation Flux Density	B_s	Gauss	3600	3250	3000	4500	4500	4500	4500	3800	4100	3800
		mT	360	325	300	450	450	450	450	380	410	380
at Field Intensity	H	Oersteds	10	10	10	10	10	10	10	12.5	10	10
		A/m	800	800	800	800	800	800	800	1000	800	800
Residual Flux Density	B_r	Gauss	2600	2000	1500	1000	1000	1000	1000	730	1100	1400
		mT	260	200	150	100	100	100	100	73	110	140
Coercive Force	H_c	Oersteds	1.60	0.40	0.20	0.10	0.10	0.10	0.10	0.10	0.10	0.04
		A/m	127	3	16	8	8	8	8	8	8	3
Relative Loss Factor	$\tan \delta$	μ_i	740	91	53	10	10	20	15	< 8	6	5
at Frequency	f	MHZ	0.10	0.10	0.10	0.10	0.10	0.10	0.10	0.010	0.010	0.10
Curie Temperature	T_c	$^{\circ}\text{C}$	> 225	> 175	> 120	> 150	> 150	> 150	> 130	> 130	> 130	> 120
Resistivity	ρ	$\Omega\text{-cm}$	10^6	10^5	10^5	10^2	10^2	10^2	10^2	35	10	1
Density		g/cm^3	4.9	4.9	4.8	4.8	4.8	4.8	4.8	4.9	4.8	4.8

Please visit www.Steward.com for the most up-to-date information.

Steward Toroids

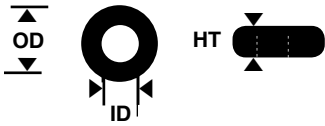

Custom Parts Also Available

Part Number	MM			INCHES			wt/k kgs	I _e mm	A _e mm ²	V _e mm ³	C ₁ mm ⁻¹	MLT mm/Turn
	OD	ID	HT	OD	ID	HT						
*T0100-00P	2.54	1.27	1.27	0.100	0.050	0.050	0.02	5.531	0.775	4.286	7.138	3.81
*T0100-20P	2.54	1.27	0.76	0.100	0.050	0.030	0.01	5.531	0.465	2.572	11.896	2.79
*T0100-30P	2.54	1.27	0.99	0.100	0.050	0.039	0.02	5.531	0.604	3.343	9.151	3.25
*T0100-40P	2.54	1.27	2.54	0.100	0.050	0.100	0.05	5.531	1.550	8.572	3.569	6.35
*T0101-10P	2.54	1.50	0.99	0.100	0.059	0.039	0.02	6.059	0.504	3.054	12.021	3.02
*T0115-00P	2.92	1.63	1.78	0.115	0.064	0.070	0.04	6.749	1.119	7.553	6.030	4.85
*T0115-10P	2.92	1.63	2.41	0.115	0.064	0.095	0.05	6.749	1.519	10.251	4.443	6.12
*T0119-00P	3.05	1.27	1.27	0.120	0.050	0.050	0.04	5.988	1.060	6.345	5.651	4.32
*T0119-10P	3.05	1.27	0.76	0.120	0.050	0.030	0.02	5.988	0.636	3.807	9.419	3.30
*T0119-20P	3.05	1.27	0.86	0.120	0.050	0.034	0.03	5.988	0.721	4.314	8.310	3.51
*T0119-40P	3.05	1.27	2.54	0.120	0.050	0.100	0.07	5.988	2.119	12.690	2.826	6.86
*T0120-00P	3.05	1.78	1.52	0.120	0.070	0.060	0.04	7.226	0.945	6.826	7.649	4.32
*T0120-80P	3.05	1.78	2.03	0.120	0.070	0.080	0.05	7.226	1.260	9.101	5.737	5.33
*T0121-20P	3.05	1.52	2.06	0.120	0.060	0.081	0.05	6.637	1.506	10.000	4.406	5.64
*T0122-00P	3.05	1.65	1.65	0.120	0.065	0.065	0.04	6.938	1.118	7.755	6.207	4.70
*T0122-30P	3.05	1.65	2.39	0.120	0.065	0.094	0.06	6.938	1.616	11.215	4.292	6.17
*T0130-00P	3.30	1.27	1.27	0.130	0.050	0.050	0.05	6.195	1.196	7.412	5.178	4.57
*T0135-00P	3.43	1.78	1.27	0.135	0.070	0.050	0.04	7.619	1.011	7.707	7.533	4.19
*T0135-10P	3.43	1.78	2.06	0.135	0.070	0.081	0.07	7.619	1.639	12.485	4.650	5.77
*T0135-20P	3.43	1.78	0.86	0.135	0.070	0.034	0.03	7.619	0.688	5.241	11.078	3.38
*T0135-30P	3.43	1.78	2.54	0.135	0.070	0.100	0.08	7.619	2.023	15.414	3.766	6.73
*T0135-40P	3.43	1.78	1.78	0.135	0.070	0.070	0.06	7.619	1.416	10.790	5.381	5.21
*T0135-60P	3.43	1.78	1.52	0.135	0.070	0.060	0.05	7.619	1.214	9.248	6.277	4.70
*T0137-00P	3.43	1.52	0.76	0.135	0.060	0.030	0.03	6.989	0.687	4.803	10.168	3.43
*T0145-00P	3.68	1.65	2.54	0.145	0.065	0.100	0.11	7.543	2.447	18.454	3.083	7.11
*T0153-00P	3.94	1.78	1.27	0.155	0.070	0.050	0.06	8.097	1.301	10.534	6.224	4.70
*T0153-40P	3.94	1.78	2.54	0.155	0.070	0.100	0.12	8.097	2.602	21.068	3.112	7.24

Steward Toroids

Part Number	A_L (nH per turn squared)								
	Common Mode			DC Bias			Telecom		Other
	25	28	38	36	46	56	42	40	35
	125	850	1700	4500	4000	5500	7500	10000	5000
*T0100-00P	22	150	299	--	--	--	--	1761	880
*T0100-20P	13	90	180	475	--	--	792	1056	528
*T0100-30P	--	117	--	--	--	--	--	1373	687
*T0100-40P	--	--	--	1585	1408	1937	--	--	--
*T0101-10P	--	--	--	--	--	--	--	1045	--
*T0115-00P	--	--	--	938	834	1146	--	--	1042
*T0115-10P	--	--	--	1273	1131	1556	--	--	--
*T0119-00P	28	189	378	--	--	--	1668	2224	1112
*T0119-10P	--	113	--	--	--	--	--	--	667
*T0119-20P	--	129	--	--	--	--	--	--	--
*T0119-40P	--	--	--	2001	1779	2446	--	--	--
*T0120-00P	21	140	279	--	--	--	--	--	821
*T0120-80P	--	186	--	986	876	1205	--	--	--
*T0121-20P	--	--	--	--	1141	--	--	--	--
*T0122-00P	--	172	--	--	--	--	--	--	--
*T0122-30P	--	--	--	1317	1171	1610	--	--	--
*T0130-00P	--	206	--	--	--	--	--	--	--
*T0135-00P	21	142	284	751	667	--	1251	1668	834
*T0135-10P	--	230	--	1216	1081	1486	2027	2703	1351
*T0135-20P	14	96	--	510	--	--	--	1134	--
*T0135-30P	--	--	--	--	--	--	--	3336	--
*T0135-40P	--	--	--	1051	--	--	--	--	1168
*T0135-60P	25	170	340	901	--	--	--	--	1001
*T0137-00P	--	--	--	556	--	--	--	--	--
*T0145-00P	--	--	--	--	1630	--	--	--	--
*T0153-00P	--	--	--	909	--	--	1514	--	--
*T0153-40P	--	--	--	1817	--	2221	--	--	--

Catalog Parts are designated by AL value.

Please visit www.Steward.com for the most up-to-date information.

Steward Toroids

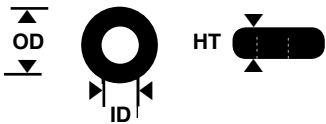

Custom Parts Also Available

Part Number	MM			INCHES			wt/k kgs	l _e mm	A _e mm ²	V _e mm ³	C ₁ mm-1	MLT mm/Turn
	OD	ID	HT	OD	ID	HT						
*T0153-60P	3.94	1.78	1.52	0.155	0.070	0.060	0.07	8.097	1.561	12.641	5.186	5.21
*T0153-70P	3.94	1.78	1.78	0.155	0.070	0.070	0.08	8.097	1.821	14.748	4.445	5.72
*T0154-00P	3.94	1.68	1.37	0.155	0.066	0.054	0.07	7.831	1.459	11.429	5.366	5.00
*T0155-00P	3.94	2.24	2.54	0.155	0.088	0.100	0.10	9.196	2.104	19.353	4.370	6.78
*T0155-10P	3.94	2.24	1.27	0.155	0.088	0.050	0.05	9.196	1.052	9.677	8.740	4.24
*T0155-20P	3.94	2.24	2.01	0.155	0.088	0.079	0.08	9.196	1.663	15.289	5.531	5.72
*T0155-80P	3.94	2.24	1.65	0.155	0.088	0.065	0.07	9.196	1.368	12.580	6.723	5.00
*T0157-10P	3.99	2.01	0.99	0.157	0.079	0.039	0.05	8.715	0.944	8.223	9.235	3.96
*T0190-00P	4.83	2.29	2.54	0.190	0.090	0.100	0.18	10.196	3.080	31.401	3.311	7.62
*T0190-10P	4.83	2.29	1.27	0.190	0.090	0.050	0.09	10.196	1.540	15.701	6.621	5.08
*T0195-20P	4.95	1.57	0.76	0.195	0.062	0.030	0.06	8.312	1.155	9.601	7.196	4.90
*T0231-00P	5.84	3.05	1.52	0.230	0.120	0.060	0.14	13.026	2.055	26.775	6.337	5.84
*T0231-10P	5.84	3.05	3.05	0.230	0.120	0.120	0.29	13.026	4.111	53.549	3.169	8.89
*T0231-20P	5.84	3.05	3.18	0.230	0.120	0.125	0.30	13.026	4.282	55.780	3.042	9.14
*T0231-30P	5.84	3.05	2.54	0.230	0.120	0.100	0.24	13.026	3.426	44.624	3.802	7.87
*T0231-50P	5.84	3.05	2.03	0.230	0.120	0.080	0.19	13.026	2.741	35.699	4.753	6.86
*T0231-70P	5.84	3.05	4.29	0.230	0.120	0.169	0.41	13.026	5.790	75.415	2.250	11.38
*T0238-00P	6.05	2.95	3.18	0.238	0.116	0.125	0.34	12.978	4.713	61.163	2.754	9.45
*T0301-00P	7.62	3.18	4.78	0.300	0.125	0.188	0.88	14.970	9.960	149.103	1.503	14.00
*T0315-00P	8.00	3.18	4.78	0.315	0.125	0.188	0.99	15.284	10.736	164.094	1.424	14.38
*T0325-00P	8.26	4.45	4.78	0.325	0.175	0.188	0.89	18.730	8.812	165.042	2.126	13.36

Steward Toroids

Part Number	A_L (nH per turn squared)								
	Common Mode			DC Bias			Telecom		Other
	25	28	38	36	46	56	42	40	35
	125	850	1700	4500	4000	5500	7500	10000	5000
*T0153-60P	--	--	--	1090	969	1333	--	--	--
*T0153-70P	--	--	--	1272	--	--	--	2827	--
*T0154-00P	--	--	--	--	--	--	--	--	1171
*T0155-00P	--	244	--	1294	--	--	2157	2876	--
*T0155-10P	18	122	244	--	--	--	--	1438	719
*T0155-20P	--	193	--	--	--	--	--	2272	1136
*T0155-80P	--	159	--	--	--	--	--	--	--
*T0157-10P	--	116	--	--	--	--	--	1361	--
*T0190-00P	--	--	--	--	--	--	2847	3796	--
*T0190-10P	--	161	--	--	--	--	--	--	949
*T0195-20P	--	--	--	786	--	--	--	--	--
*T0231-00P	25	169	337	892	--	--	--	--	991
*T0231-10P	--	337	--	--	--	--	2974	3966	1983
*T0231-20P	--	351	--	--	--	--	3098	4131	2066
*T0231-30P	--	--	--	--	--	--	--	--	1652
*T0231-50P	--	--	--	--	--	--	--	2644	--
*T0231-70P	--	--	--	--	--	--	--	5585	--
*T0238-00P	--	--	--	--	--	--	3423	4564	--
*T0301-00P	--	--	--	--	--	--	6271	8361	4181
*T0315-00P	--	--	--	--	--	--	--	8827	--
*T0325-00P	--	--	--	--	--	--	4434	5912	--

Catalog Parts are designated by AL value.

Please visit www.Steward.com for the most up-to-date information.

Steward Medium & Large Toroids

Part Number	Standard Toroid Sizes						wt/k kgs	L _e mm	A _e mm ²	V _e mm ³	C ₁ mm ⁻¹	MLT mm/Turn	A _L (nH per turn squared)		
	MM			INCHES									35 (5000 μi)	39 (7000 μi)	40 (10000 μi)
	OD	ID	HT	OD	ID	HT									
*T0375-00H	9.53	4.75	6.35	0.375	0.187	0.250	1.66	20.716	14.579	302.005	1.42	17.48	4422	--	8844
*T0375-10H	9.53	4.75	3.18	0.375	0.187	0.125	0.83	20.716	7.301	151.244	2.84	11.14	2214	--	4429
*T0375-30H	9.53	4.75	4.78	0.375	0.187	0.188	1.25	20.716	10.963	227.108	1.89	14.33	3325	--	6650
*T0394-00H	10.00	5.00	5.00	0.394	0.197	0.197	1.44	21.788	12.018	261.844	1.81	15.01	3466	--	--
*T0394-20H	10.00	5.00	4.00	0.394	0.197	0.157	1.15	21.788	9.602	209.209	2.27	12.99	--	3877	5538
*T0395-10H	10.00	6.00	4.00	0.394	0.236	0.157	0.99	24.007	7.886	189.327	3.04	12.03	--	--	4128
*T0472-00H	12.00	6.00	4.00	0.472	0.236	0.157	1.65	26.141	11.515	301.024	2.27	13.99	2768	3875	5536
*T0500-00H	12.70	7.92	3.18	0.500	0.312	0.125	1.20	31.216	7.449	232.536	4.19	11.13	1499	2099	2999
*T0500-10H	12.70	7.92	6.35	0.500	0.312	0.250	2.40	31.216	14.898	465.071	2.10	17.48	2968	4198	5936
*T0500-40H	12.70	7.92	5.08	0.500	0.312	0.200	1.92	31.216	11.919	372.057	2.62	14.94	2396	3359	4798
*T0501-00H	12.70	7.14	4.78	0.500	0.281	0.188	2.02	29.500	12.920	381.139	2.28	15.11	2715	--	5430
*T0501-10H	12.70	7.14	6.35	0.500	0.281	0.250	2.68	29.500	17.181	506.834	1.72	18.26	3659	5123	7318
*T0520-00H	13.21	7.37	3.96	0.520	0.290	0.156	1.82	30.551	11.251	343.728	2.72	13.77	2314	--	--
*T0520-20H	13.21	7.37	6.05	0.520	0.290	0.238	2.78	30.551	17.165	524.406	1.78	17.93	--	4942	--
*T0551-00H	14.00	9.00	5.00	0.551	0.354	0.197	2.20	34.977	12.293	429.970	2.85	15.00	--	3092	4416
*T0625-00H	15.88	8.89	4.70	0.625	0.350	0.185	3.11	36.804	15.959	587.354	2.31	16.38	2725	--	5449
*T0632-00H	16.00	9.00	5.00	0.630	0.354	0.197	3.35	37.167	17.062	634.133	2.18	17.01	--	--	5763
*T0634-00H	16.00	12.00	8.00	0.630	0.472	0.315	3.43	43.363	15.944	691.305	2.72	20.00	--	3222	4603
*T0711-00H	18.00	10.00	7.00	0.709	0.394	0.276	6.01	41.574	27.252	1132.994	1.53	22.00	4115	--	8229
*T0787-10H	20.00	10.00	10.00	0.787	0.394	0.394	11.49	43.560	48.003	2091.035	0.91	30.00	6931	--	13863
*T0866-00H	22.00	14.00	6.50	0.866	0.551	0.256	7.17	54.654	25.574	1397.741	2.14	21.01	2940	--	5880
*T0866-10H	22.00	14.00	8.00	0.866	0.551	0.315	8.83	54.654	31.468	1719.877	1.74	24.00	--	5060	7240
*T0870-00H	22.10	13.72	6.35	0.870	0.540	0.250	7.30	54.179	26.114	1414.839	2.07	21.08	3020	--	6040
*T0870-10H	22.10	13.72	12.70	0.870	0.540	0.500	14.60	54.179	52.228	2829.677	1.04	33.78	6040	--	12080
*T0984-00H	25.00	15.00	13.00	0.984	0.591	0.512	19.93	60.184	63.628	3829.426	0.95	36.01	--	--	13290
*T1000-00H	25.40	15.50	10.00	1.000	0.610	0.394	15.51	61.693	48.571	2996.469	1.27	29.90	4830	--	9660
*T1142-00H	29.00	19.00	7.49	1.142	0.748	0.295	13.78	73.204	36.939	2704.070	1.98	24.99	3170	4750	6340
*T1142-10H	29.00	19.00	13.80	1.142	0.748	0.543	25.37	73.204	67.993	4977.322	1.08	37.60	--	8169	11671
*T1220-00H	31.00	19.00	13.00	1.220	0.748	0.512	29.88	75.973	76.420	5767.633	0.99	38.00	--	--	12728
*T1417-00H	36.00	23.00	10.00	1.417	0.906	0.394	29.38	84.664	63.874	5727.244	1.40	33.00	4543	--	9085
*T1417-10H	36.00	23.00	15.00	1.417	0.906	0.591	44.07	84.664	95.812	8590.866	0.94	43.00	6743	--	13440

Balun Cores

Part Number	Fig #	Length A (mm)	Width B (mm)	Height C (mm)	ID D (mm)	E (mm)	wt/k kgs	Electrical Properties					
								25		28		35	
								L	Z @ 300 MHz 3 Turns	L	Z @ 150 MHz 1 Turn	L	Z @ 10 MHz 1 Turn
*N0136-00P	1	3.45	2.01	2.36	0.86	1.45	0.06	0.050	14.26	0.576	37.00	2.96	50.00
*N0136-10P	1	3.45	2.01	1.50	0.86	1.45	0.04	0.029	8.00	0.197	20.76	--	--
*N0136-30P	1	3.45	2.01	1.65	0.86	1.45	0.06	--	--	--	--	1.60	30.86
*N0138-00P	1	3.45	2.01	0.68	0.86	1.45	0.02	0.014	3.63	--	--	--	--
*N0252-000	2	6.35	--	6.35	1.19	3.05	0.88	0.383	90.07	--	--	9.90	105.00
*N0277-00P	1	7.04	4.06	6.20	1.80	2.90	0.61	0.229	57.00	1.920	114.00	--	--
*N0372-00P	3	9.40	5.35	8.00	2.59	5.24	1.46	--	--	--	--	7.00	154.00

Figure #1

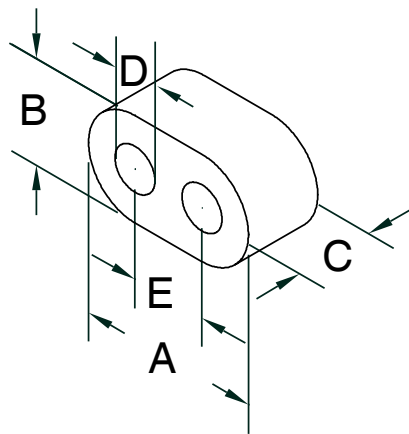

Figure #2

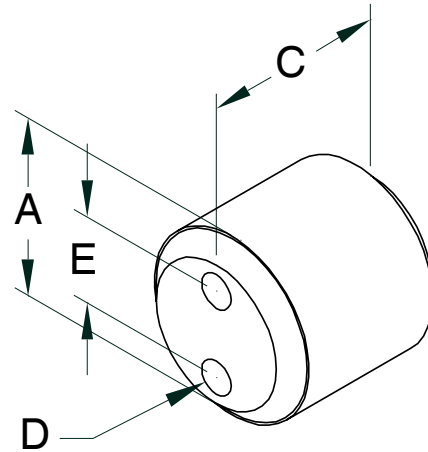
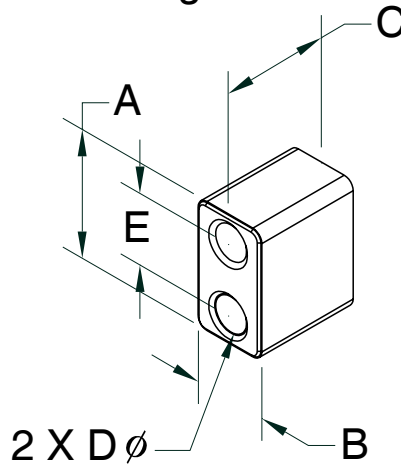

Figure #3



Please visit www.Steward.com for the most up-to-date information.

Ferrite Property Measurement

Initial Permeability, Losses & Inductance Factor

Three properties can be measured, using an inductance meter to measure an equivalent series inductance and resistance. From these values, and a knowledge of the inductor sample, these parameters may be derived. These are:

Inductance Factor, A_L , given by

$$A_{L[nH/r^2]} = \frac{L_{[nH]}}{n^2}$$

where L is the inductance in nH, and n is the number of turns,

Initial Permeability (the real part only), μ_i , given by

$$\mu_i = \frac{L}{L_o}$$

where L is the measured inductance, and L_o is the air core inductance.

Losses, described by $\tan\delta/\mu_i$, given by

$$\frac{\tan \delta}{\mu_i} = \frac{L_o R_s}{\omega L^2}$$

where μ_i is the initial permeability, $\tan\delta/\mu_i$ is the lossy component of the total reactance, ω is $2\pi f$, and other terms as defined above.

Equipment: Precision LCR meter.

Test Conditions: Flux Density < 10 Gauss

Frequency: as specified.

The core is stabilized at room temperature (22° C) and wound with the correct number of turns. Since most LCR meters have a resistor, usually 100 Ω , in series between the oscillator and the unknown to be measured, the number of

turns should be chosen such that the reactance of the core is at least 10 Ω . This condition ensures that a minimum of 10% of the test signal is applied to the core.

With the frequency set and voltage adjusted for test conditions, the LCR meter will measure R_s and L_s . Caution: When measuring very small value reactances, be sure to test the accuracy of the measurement instrument.

Changes in Inductance versus Temperature & Curie Temperature

These two tests may be performed using an inductance meter and a temperature controlled oven. The inductance meter will measure R_s and L_s as described above.

Equipment: Precision LCR meter
Temperature Controlled Chamber for DUT

Test Conditions: Flux Density <10 Gauss
Temperature as specified

Frequency: 10 to 100 kHz.

The cores to be tested are placed in the temperature chamber and subjected to two stabilizing temperature cycles, with approximately two hours at each temperature.

The first inductance measurement, L_1 is made at the lowest temperature, θ_1 , after a thirty minute soak at that temperature. This procedure is repeated up to the highest specified temperature, θ_2 . A measurement made in the 20°C to 25°C range is considered the reference inductance, L_{ref} , at the reference temperature, θ_{ref} .

After measuring the highest temperature, a final measurement should be made again at the reference temperature. Both measurements of the reference inductance should be the same within the bridge accuracy. If these two readings are significantly dissimilar, more temperature stabilizing cycles may be needed to eliminate irreversible inductance changes in the samples.

Ferrite Property Measurement

From the inductance reading at various temperatures, the temperature coefficient of inductance may be calculated from

$$T.C. = \frac{L_{\theta_2} - L_{ref}}{L_{ref}(\theta_2 - \theta_{ref})} = \frac{L_{\theta_2} - L_{\theta_1}}{L_{ref}(\theta_2 - \theta_1)}$$

where all terms are as defined above.

For Curie Temperature measurement, temperature is slowly increased while inductance is monitored. The temperature at which core inductance decreases to 10% of the room temperature value is the Curie Temperature.

Flux Density, Residual Flux Density, Coercive Force, & Amplitude Permeability

There are four intrinsic material parameters that can be determined from the B-H loop measurement. The core under test is used as a transformer and the relationship between winding current (H) and secondary winding integrated voltage (B) is measured. This relationship is displayed using the "X versus Y" display mode on an oscilloscope. Magnetic terms are readily expressed in electrical terms to calibrate the display in units of Oersteds (Oe) versus Gauss (G). Once this calibration is achieved, salient points on the B-H curve may be easily obtained.

Equipment: Function Generator
Amplifier
RC Network
Dual Channel Oscilloscope

The test circuit is as shown at the right. Resistor R_1 is kept small in comparison with the inductive reactance of the wound sample. Cores must be properly installed and wound with primary and secondary winding. Field strength, H, is set by varying the current which is read as voltage across resistor R_1 .

$$H_{[Oe]} = \frac{0.4\pi nI}{l_{e[cm]}} = \frac{0.4\pi n_p V_p}{l_{e[cm]} R_1}$$

Flux density in the core is determined by integrating the secondary voltage using the RC circuit.

$$B_{[G]} = \frac{R_2 C V_p 10^8}{n_s A_{e[cm^2]}}$$

where R_2 is the integrating resistance, and C is the integrating capacitor.

From the displayed hysteresis loop saturation flux density, B_s , valueVs for coercive force, H_c , and residual flux density, B_r , may be determined once the oscilloscope is calibrated for field strength H and Flux Density.

Finally, amplitude permeability, μ_a , is given by

$$\mu_a = \frac{B}{H}$$

where B represents peak flux density between 10 Gauss and saturation, an H is the corresponding field strength.

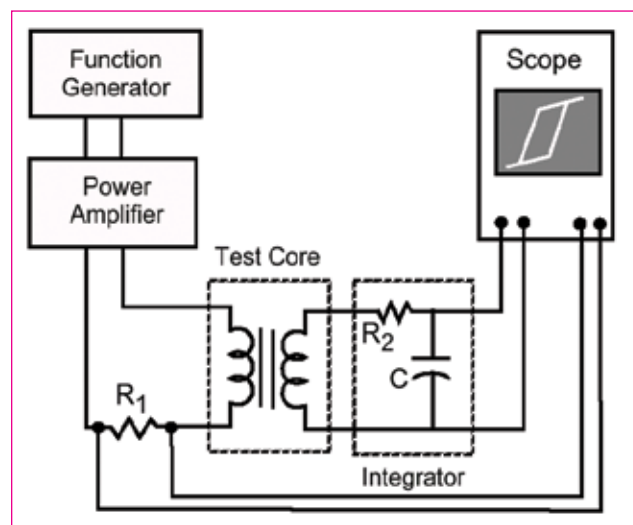

Test set up for measuring parameters of the B-H Loop.

Please visit www.Steward.com for the most up-to-date information.

Ferrite Property Measurement

Pulse Characteristics

An open collector drive circuit is used to drive a pulse through a transformer with the secondary open circuited. The effect of the transformer on the pulse is observed by monitoring waveforms.

Equipment: Pulse Generator
 DC Power Supply
 Pulse Drive Circuit—appropriate for application
 Dual Channel Oscilloscope
 Current Probe

Test Conditions: Pulse Amplitude, Pulse Width, and Pulse Repetition Rate as specified.
 Temperature; 23°C ± 3°C.

The test toroid to be measured is wound with a sufficient number of turns to produce at least 100 µH of inductance. The core is excited by applying square voltage pulses. The test circuit is shown below.

Pulse inductance, L_p , pulse Inductance Factor, A_{LP} , and the voltage time product, E-T, are measured in accordance with section 16.7 of IEC367-1.

Pulse inductance is specified as greater than 90% of sine wave initial inductance.

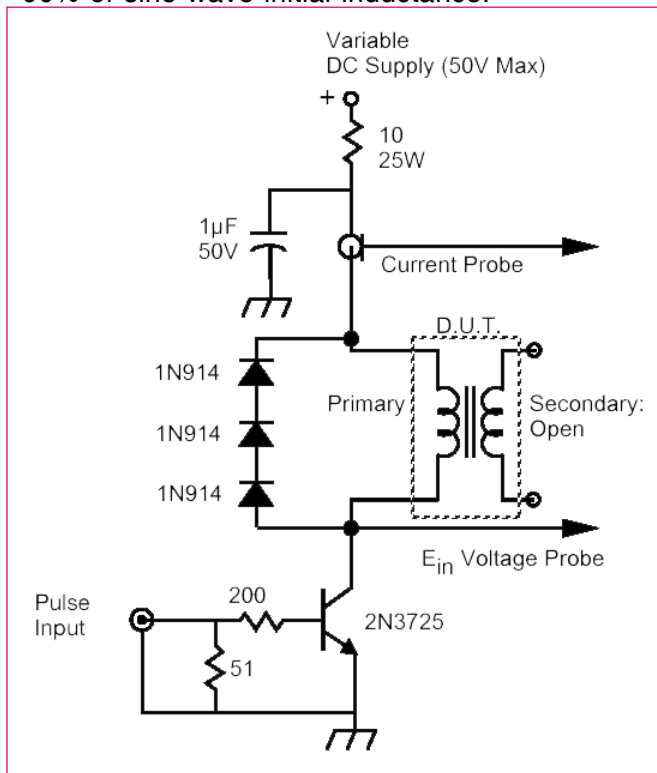

Test set up for measuring pulse characteristics

Power Loss

Power loss is readily measured using a Volt-Amp-Watt (VAW) meter.

Equipment: Signal Generator
 Power Amplifier
 Clark Hess 256 VAW Meter
 Temperature Chamber

The equipment is connected as shown below. Frequency is set and voltage is adjusted to the desired flux density level, given by the relation

$$E_{[V_{rms}]} = 4.44fnB_{[G]}A_{[cm^2]}2 \cdot 10^{-8}$$

Power losses are indicated by the VAW meter in watts. Measurements are made as rapidly as possible to avoid temperature rise in the samples.

Material power loss density is determined by dividing the measured power loss by the effective volume of the ferrite core.

A VAW meter may also be used to measure magnetizing current, I_m . This value can be used to calculate the winding loss ($I_m^2 R_{ac}$), a part of the total measured power loss.

Accuracy at higher frequencies is highly dependant on phase shift between the voltage and current.

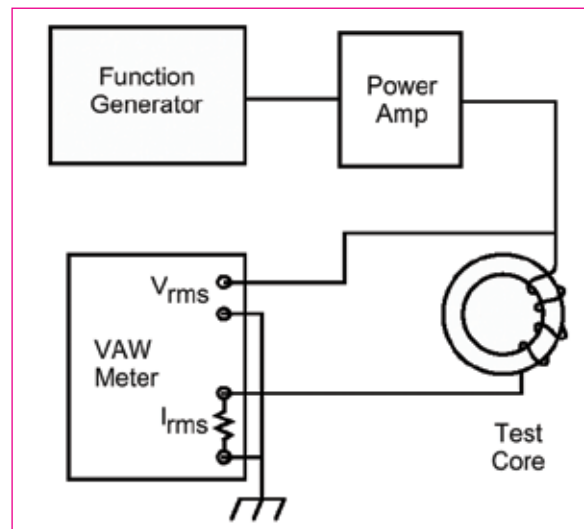

Test set up for measuring power loss.

Ferrite Property Measurement

Measurement of Impedance Of Ferrite Components

The most common property referenced for soft magnetic materials is permeability. Impedance is a complex property comprised of imaginary (reactive) and real (resistive) components. At the lower end of the RF scale, impedance can be calculated from inductance as $Z \approx 2\pi fL = X_L$ and is dominated by the reactive component of permeability.

As frequency increases, impedance is driven by the resistive component and can be calculated as $Z = \sqrt{R^2 + (j\omega L)^2}$, where R represents the resistive component and $j\omega L$ represents the reactive component. At higher frequencies permeability will approach zero and impedance will reach a maximum value comprised of a purely resistive component. Impedance, like permeability, varies with temperature, frequency, signal current, DC bias, and the presence of any extraneous fields.

The useful impedance obtained from a ferrite component depends on its application, number of turns, and winding method. See below for

an illustration of the effect of differential versus common mode winding techniques on the net impedance of a core.

Impedance measurements are made on an RF impedance analyzer. Measurements for this catalog were made on a Hewlett-Packard E4991A Network/Spectrum Analyzer with a E4991A Impedance Test Kit. All impedance curves represent gross measurements with number of turns and DC Bias current applied as shown (unless noted other-wise). In all cases the length of the conductive path between the part under test and the test fixture is kept to a minimum and in a fixed position to minimize parasitic capacitance.

All impedance measurements with DC Bias utilize the internal circuitry of the impedance analyzer. Measurements are also possible with an external source of DC current using an RF choke and a blocking capacitor to isolate the bias circuit from the RF circuit.

IMPEDANCE vs. DC BIAS COMMON vs. DIFFERENTIAL MODE WINDING

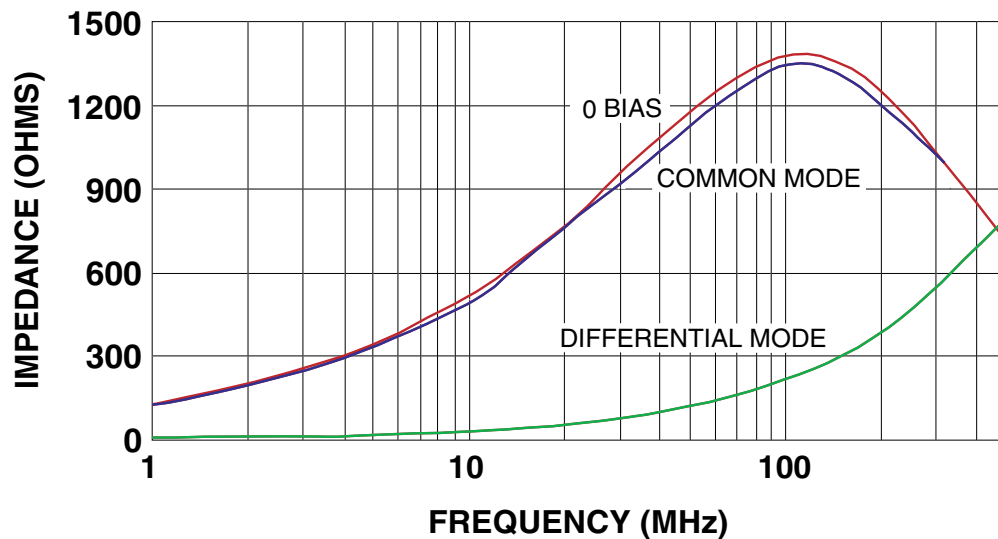

28T0155-200, 10 AMP-TURNS

These curves show the effect of ten amp-turns of DC bias on the same core wound two different ways. In the differential mode, wherein there is a single winding carrying direct current, the core is pushed far into saturation (ten amp-turns on a T0155-200 corresponds to 13.7 Oersteds). In the common mode, wherein the direct current returns through a coil of the opposite winding direction and an equal number of turns, the only deviation from zero-bias arises from leakage inductance, which is inherently low in toroids.

Please visit www.Steward.com for the most up-to-date information.

Terminology

The following glossary of terms is adapted from the Magnetic Materials Producers Association publication SFG-92 and other sources.

Air Core Inductance (L_0 [Henry]): The inductance that would be measured if the core had unity permeability and the flux distribution remained unaltered.

Circular Mils (c.m. [mils²]): The cross sectional area of a circular conductor calculated as a square conductor, ie, area in c.m. is D^2 , where D is the diameter of the wire. See also "Square Mils."

Coercive Force (H_c [Oe; Amp/m]): The magnetization field strength required to bring the magnetic flux density of a magnetized material to zero. See "Field Strength."

Common Mode Current: The component of signal current that induces electric and magnetic fields that do not tend to cancel one another. For example, in a circuit with one outgoing signal conductor and one return ("ground") conductor, the common mode current is the component of the total signal current that flows in the same direction on both conductors. Common mode current is the primary source of EMI in many electronic systems.

Common Mode Type I: On a single phase Wye bus, the conduction mode in which phase, neutral, and ground currents are in phase. The return current path is through the ground plane and the case.

Common Mode Type II: On a single phase Wye bus, the conduction mode in which phase and neutral currents are in phase, but the green wire currents are the return path, therefore 180° out of phase.

Common Mode Voltage: The voltage that drives directed common mode (noise) currents.

Core Constant (C_1 [cm⁻¹; mm⁻¹]): The summation of the magnetic path length of each section of the circuit divided by the corresponding area of the same section. See section entitled "Magnetic Design Formulas." C_1 is a frequently useful ratio in the analysis and prediction of core performance.

Core Constant (C_2 [cm⁻³; mm⁻³]): The summation of the magnetic path length of each section of the magnetic circuit divided by the square of the corresponding magnetic area of the same section. See section entitled "Magnetic Design Formulas."

Curie Temperature (T_c [°C]): The transition temperature above which a ferrite loses its ferromagnetic properties. Usually defined as the temperature at which μ_i falls to 10% of its room temperature value.

Dielectric Withstanding Voltage (DWV [V]): DWV is the voltage level at which the dielectric breaks down, allowing conduction between isolated conductors or between a conductor and the core. Isolation, or Hipot is the ability of a transformer to withstand a specific breakdown voltage between the primary and secondary windings.

Differential Mode: A current conduction mode in which currents, relative to two conductors, are flowing 180° out of phase, with equal magnitude within the conductors.

Differential Mode Current: The intended signal currents that are equal and oppositely directed on pairs of signal and return ("ground") conductors.

Differential Mode Voltage: The voltage that drives equal and oppositely directed currents to achieve an intended circuit function; the source of differential mode currents.

Disaccommodation (D): The proportional change of permeability after a disturbance of a magnetic material, measured at constant temperature, over a given time interval.

Terminology

Disaccommodation Factor (DF): The disaccommodation factor is the disaccommodation after magnetic conditioning divided by the permeability of the first measurement times \log_{10} of the ratio of time interval.

Effective Area (A_e [cm²; mm²]): For a magnetic core of a given geometry, the magnetic cross-sectional area that a hypothetical toroidal core of the same material properties would possess to be the magnetic equivalent to the given core.

Effective Length (l_e [cm; mm]): For a magnetic core of a given geometry, the magnetic length that a hypothetical toroidal core of the same material properties would possess to be the magnetic equivalent to the given core.

Effective Volume (V_e [cm³; mm³]): For a magnetic core of a given geometry, the magnetic volume that a hypothetical toroidal core of the same material properties would possess to be the magnetic equivalent to the given core.

Field Strength (H [Oe; Amp/m]): The parameter characterizing the amplitude of ac or dc field strength. Field strength is determined by the magnitude of current and geometry of the windings.

Flux Density (B [Gauss; Tesla]): The corresponding parameter for the induced magnetic field in an area perpendicular to the flux path. Flux density is determined by the field strength and permeability of the medium in which it is measured.

Impedance Z [Ohm]: The impedance of a ferrite may be expressed in terms of its complex permeability:

$$Z = j\omega L_s + R_s = j\omega L_o (\mu'_s - j\mu''_s) \text{ (ohm)}$$

Incremental Permeability [μ_Δ]: The permeability of a magnetic material about a specified operating point and applied H (especially under DC bias). The incremental permeability is expressed as the slope of the B-H characteristic about the given operating point.

$$\mu_\Delta = \frac{\Delta B}{\Delta H}$$

Inductance Factor (A_L): A constant for a given geometrical shape that when multiplied by the square of the number of turns, gives the inductance in nano Henrys. Initial permeability (flux density of less than 10 Gauss) is assumed in the inductance factor.

Insulation Resistance [Ohm]: The insulation properties of the insulating material as measured in Ohms.

Leakage Flux: Leakage flux is the small fraction of the total magnetic flux in a transformer or common mode choke that does not contribute to the magnetic coupling of the windings of the device. In a transformer with a single set of primary and secondary windings, the leakage flux is that portion of flux that is produced by the primary that does not link the secondary. The presence of leakage flux in a transformer or common mode choke is modeled as a small "leakage" inductance in series with each winding. In a multi-winding choke or transformer, leakage inductance is the inductance measured at one winding with all other windings short circuited.

Leakage Inductance (L_λ [Henry]): That component of inductance that results from non-ideal coupling of flux to a core and/or other windings. As applied to the primary side of a transformer, the quotient of flux *not* coupled to the secondary winding and the current in the primary winding. As applied to an inductor, the quotient of flux outside the core and the current through the winding. In a multi-winding choke or transformer, leakage inductance is the inductance measured at one winding with all other windings short circuited.

Loss Factor ($\tan\delta/\mu$): The phase displacement between the fundamental components of the flux density and the field strength divided by the initial permeability. This term is essentially normalized loss. Note that $1/\tan\delta$ equals Q. This term is most useful as an indicator of the useful high Q bandwidth of a material. Above a specific frequency, depending on the material, loss factor normally undergoes a rapid increase due magnetic resonance. Note that a high Q is not desirable in all applications, especially EMI or filtering.

Please visit www.Steward.com for the most up-to-date information.

Terminology

Loss Tangent: The measure of the loss of a magnetic material at high operating frequencies due to the oscillation of microscopic magnetic regions within the material. The loss tangent is expressed as the ratio of the imaginary permeability component μ'' to the real permeability μ' of the material.

Magnetic Constant (μ_0 [Henry/m]): The permeability of free space. The constant μ_0 has a value of $4\pi \times 10^{-7}$.

Magnetic Field Intensity or Magnetizing Force (H): The mmf per unit length. H can be considered to be a measure of the strength or effort that the magnetomotive force applies to a magnetic circuit to establish a magnetic field. H may be expressed as $H = NI/\vartheta$, where ϑ = the mean length of the magnetic circuit in meters.

Magnetic Hysteresis: In a magnetic material, the irreversible variation of the flux density or magnetization which is associated with the change of magnetic field strength and is independent of the rate of change. Hysteresis results in the square or "open" characteristic of the B-H loop. Because it is irreversible, hysteresis results in lost energy. The amount of energy lost is related to the area within the B-H loop traversed.

Magnetically Soft Material: A magnetic material with a low coercivity.

Magnetomotive Force (MMF [Amp]): The magnetic field which induces a magnetic flux in a magnetic circuit. The total magnetomotive force is the product of turns and current. Also, the product of Magnetic Field and coil length.

Mean Length Turn (MLT [cm; mm]): The average length of a single turn around the toroid. Values in this catalog are given for single layer coils. In multi-layer coils, the length of each successive layer is longer resulting in a longer average turn length.

Parasitic Capacitance (C_p [F]): Unintentional capacitance resulting from close physical proximity of two conductors. The copper comprising the wire is separated by its insulation from the core. The capacitance is proportional to area (wire diameter) and inversely proportional to separation.

Permeability (μ): The extent to or ease with which a material can be magnetized, often expressed as the parameter relating the magnetic flux density B induced by an applied magnetic field intensity H , as $B = \mu H$. The "absolute" permeability of a given material is expressed as the product of its relative permeability μ_r (a dimensionless constant) and the free space constant μ_0 .

Permeability, amplitude (μ_a): The quotient of the peak value of flux density and peak value of applied field strength at a stated amplitude of either, with no static field present.

Permeability, incremental ($\mu\Delta$): This is the permeability derived from the incremental difference of B and H ($\Delta B/\Delta H$), as given by a small ac signal with a static field, or bias, present. Also, minor loop permeability.

Permeability, effective (μ_e): For a magnetic circuit constructed with an air gap(s), the permeability of a hypothetical homogeneous material which would provide the same reluctance.

Permeability, Free Space (μ_0): The permeability of free space, a constant.

Permeability, initial (μ_i): This is the permeability of an initially de-gaussed core driven with a small signal ($2 < B < 10$ Gauss typical) such that the permeability of a minor loop centered on the origin is measured. The drive level is specified as < 10 Gauss, and is such that the minor loop is "inside" the major loop. Note that the (amplitude) permeability initially increases with increasing field strength.

Permeability, Pulse (μP): Under stated conditions, permeability obtained from the ratio of the rate of change in flux density to the rate of change in applied field strength of the pulse field.

Power Loss Density (P [mW/cm³; kw/m³): The power absorbed by a body of ferromagnetic material and dissipated as heat when the body is subjected to an alternating field, which results in a measurable temperature rise. The total loss is divided by the volume of the body.

Quality Factor (Q): The ratio of energy stored to energy lost (reactance to resistance). For a series LR circuit, Q is $\omega L/R$. For a parallel LR circuit, Q is $R/\omega L$.

Terminology

Remanence (B_r [Gauss; Tesla]): The flux density remaining in a magnetic material when the applied field strength is reduced to zero.

Resistance: A measure of the degree to which an object opposes the passage of an electrical current resistance defined as :

$$R = \frac{V}{I}$$

where V = voltage, I = current. At Oe bins levels resistance is also

$$R = \frac{\vartheta \rho}{A}$$

where ϑ = length of conductor, ρ = resistivity, A = cross section area.

Resistivity (ρ): The intrinsic property measured in ohm-cm that quantifies a material's opposition to free electron motion. Resistivity is the reciprocal property to conductivity. The resistance of a homogeneous material of uniform cross section A and length I can be found by:

$$R = \frac{\vartheta \rho}{A}$$

Rise Time (τ_r [sec]): Rise time of a square pulse is defined as the shortest time required for the voltage level to change from a "low" state to a high "state." Time is customarily measured between voltage levels 10% and 90% of the "high" amplitude.

Saturation: The point at which the flux density B in a magnetic material does not increase with further applications of greater magnetization force H . At saturation, the slope of a materials's B - H characteristic curve becomes extremely small, with the instantaneous permeability approaching that of free space (relative permeability = 1.0)

Saturation Flux Density (B_s [Gauss; Tesla]): The maximum intrinsic induction possible in a material. This is the flux level at which additional H -field produces no additional B -field.

Single-Layer Winding: A winding for toroidal cores which will result in the full utilization of the inside circumference of the core without overlapping turns. Both the wire gauge and the thickness of the insulation will effect the number of turns which will fit on a single-layer winding.

Square Mils (mils^2): The cross sectional area of a circular conductor calculated as a circle, ie, area is πr^2 , where r is in mils. See also "Circular Mils."

Temperature Coefficient (T.C.): The normalized change of the quantity considered (inductance, for instance), divided by the difference in temperature producing it.

Turns Ratio: The ratio of the number of turns on the primary to the number of turns on the secondary.

Volt Second Product (ET [V_s]): The ET product is a parameter used to measure the transformer's ability to maintain and support a pulse signal without saturating the core. It is determined as the product of the voltage applied at the primary and the time required for the magnetizing current to reach 1.5 times its linear value. Values for ET are dependent on the core geometry, core material, and the number of turns on the winding.

Volume Resistivity (ρ [Ohm-cm]): The resistance measured by means of direct voltage of a body of ferromagnetic material having a constant cross-sectional area.

Please visit www.Steward.com for the most up-to-date information.



Steward Toroid & Balun Core Catalog
11th Edition - Rev D - 02/2006

Steward produces an extensive line of ferrite products for Inductive and EMI Filtering Applications. Products include ferrite EMI cable cores, connector plates, unique common mode chokes, can-bus chokes, high current thru hole and surface mount components, impedance chip beads, surface mount inductors, toroid inductor cores and ferrite powders. Please consult our web site, Steward's EMI and Inductive Components full catalog, or contact your nearest Steward office or representative for additional information.

Steward North America 1200 East 36th Street P.O. Box 510 Chattanooga, Tennessee 37401-0510 U.S.A. Phone: +1-423-308-1690 Fax: +1-423-308-1622 e-mail: americas@steward.com	Steward Mexico Ave. Obrero Mundial # 9 Parque Industrial Dynatech Hermosillo, Sonora 83170 Mexico Phone: +52 662 260-4832 Fax: +52 662 216 1202 e-mail: mexico@steward.com	Steward Europe 5 Cochrane Square Brucefield Industry Park Livingston EH54 9DR Scotland, UK Phone: +44-(0)-1506-414200 Fax: +44-(0)-1506-410694 e-mail: europe@steward.com	Steward Asia / Pacific 3791 Jalan Bukit Merah #10-14, E-Centre @ Redhill 159471 Singapore Phone: +65 6272 2646 Fax : +65 6272 6165 email: asia@steward.com	Steward China Fuan Industrial Zone, Leliu Town Shunde District, Foshan City, Guangdong Province P.R. China 528322 Phone: +86-757-2563 8860 Fax : +86-757-2563-8862 email: china@steward.com
---	---	--	---	---

www.steward.com